

日本語教育教材

# こんにちは

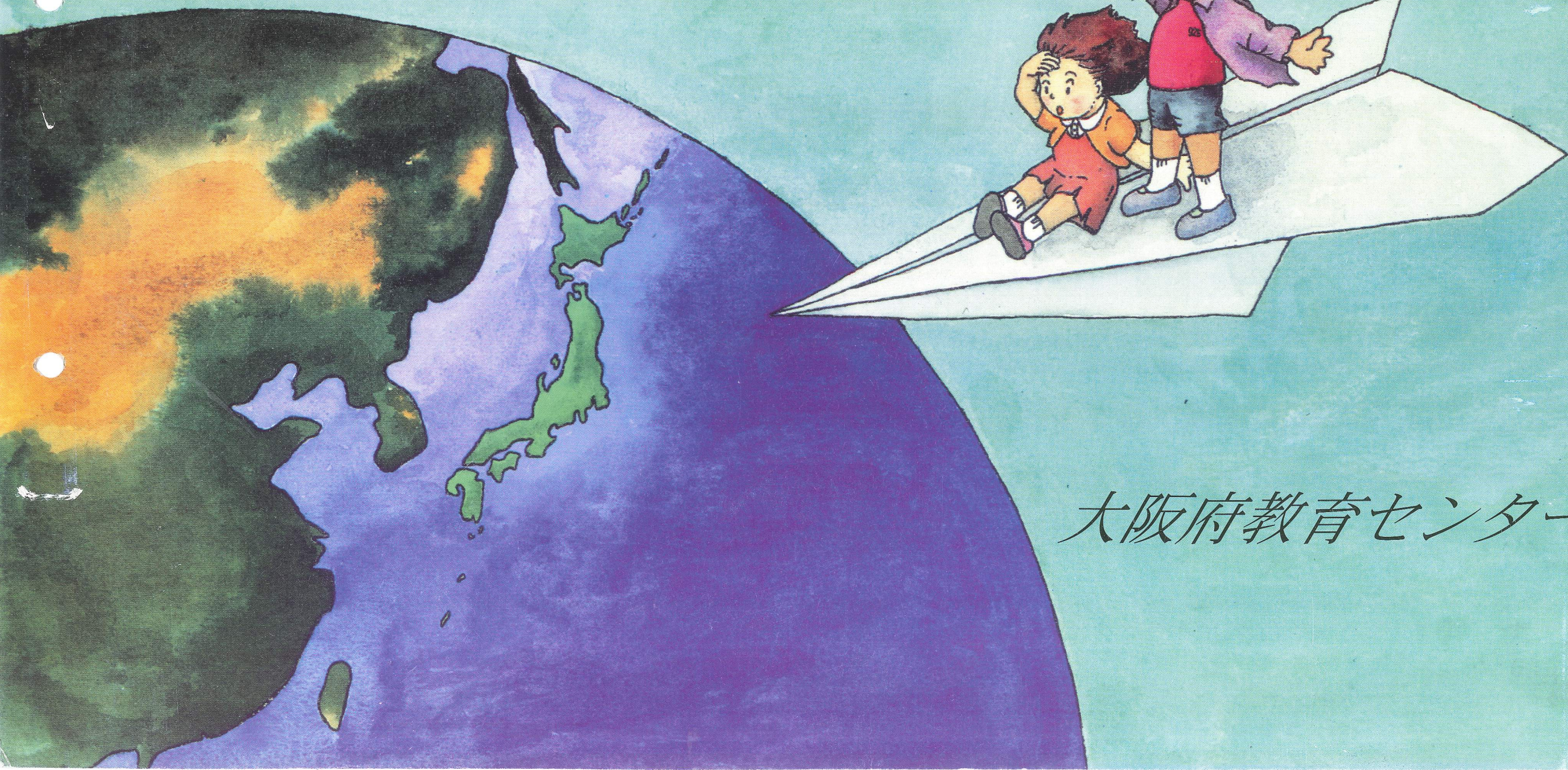

大阪府教育センター

ひらがな [ かたかな ] 50音 ㊦

ぱ	ば	だ	ざ	が
パ	バ	ダ	ザ	ガ
び	び	ぢ	じ	ぎ
ビ	ビ	ヂ	ジ	ギ
ぶ	ぶ	づ	ず	ぐ
ブ	ブ	ヅ	ズ	グ
ぺ	べ	で	ぜ	げ
ペ	ベ	デ	ゼ	ゲ
ぽ	ぼ	ど	ぞ	ご
ポ	ボ	ド	ゾ	ゴ

わ	ら	や	ま	は	な	た	さ	か	あ
ワ	ラ	ヤ	マ	ハ	ナ	タ	サ	カ	ア
(い)	り	(い)	み	ひ	に	ち	し	き	い
	リ		ミ	ヒ	ニ	チ	シ	キ	イ
(う)	る	ゆ	む	ふ	ぬ	つ	す	く	う
	ル	ユ	ム	フ	ヌ	ツ	ス	ク	ウ
(え)	れ	(え)	め	へ	ね	て	せ	け	え
	レ		メ	ヘ	ネ	テ	セ	ケ	エ
を	ろ	よ	も	ほ	の	と	そ	こ	お
ヲ	ロ	ヨ	モ	ホ	ノ	ト	ソ	コ	オ

ん  
ン 90

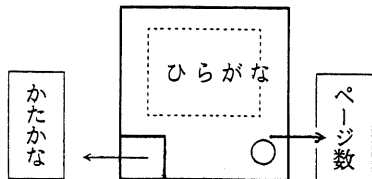

表紙と口絵  
及び場面イラスト

山中 久仁子

語彙ワーク

小林 昇一・清水 令子  
松裏 貞子・村田 知子  
山瀬 一美



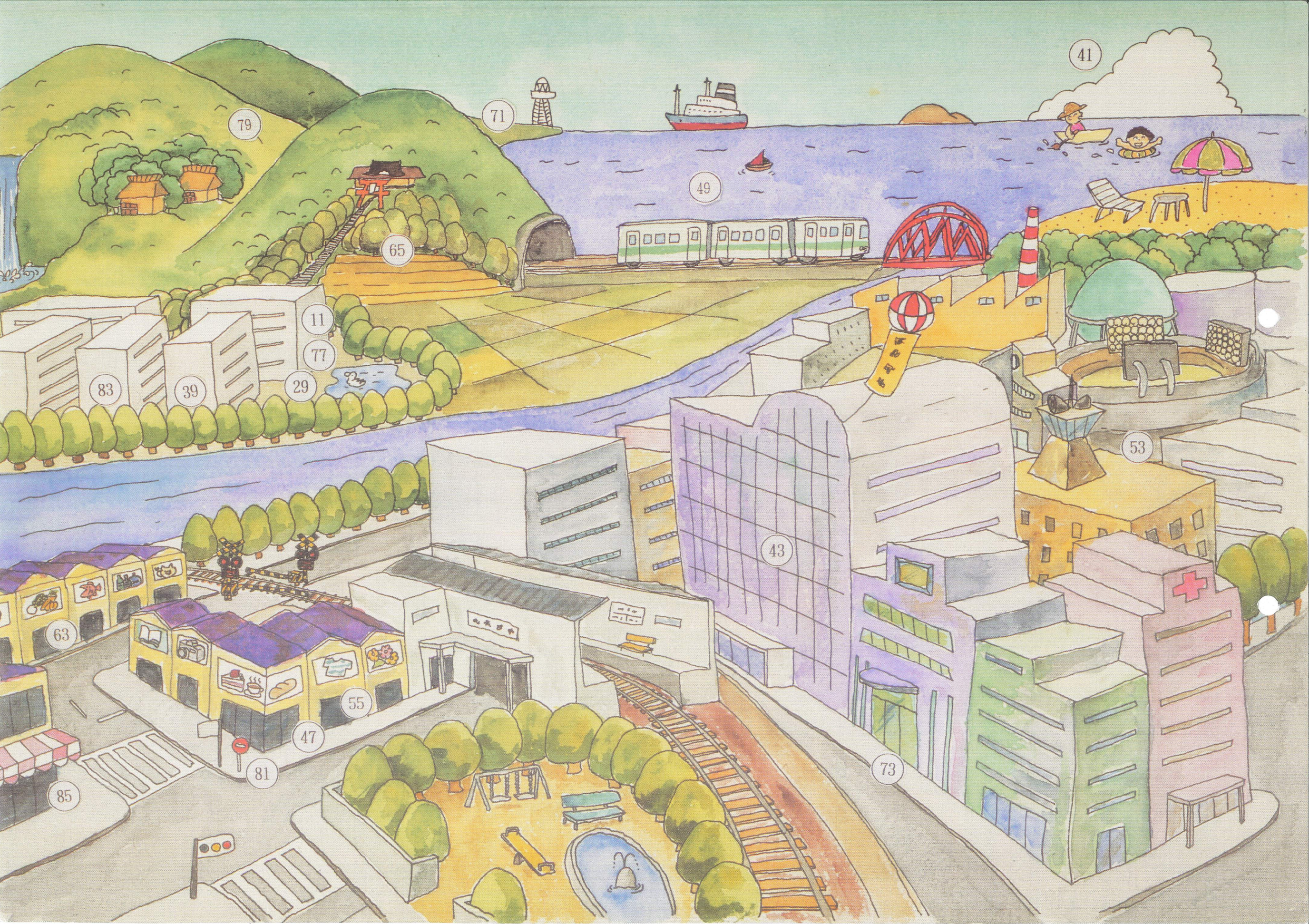

41

79

71

49

65

11

77

83

39

29

53

43

63

55

47

81

85

73



# はじめまして

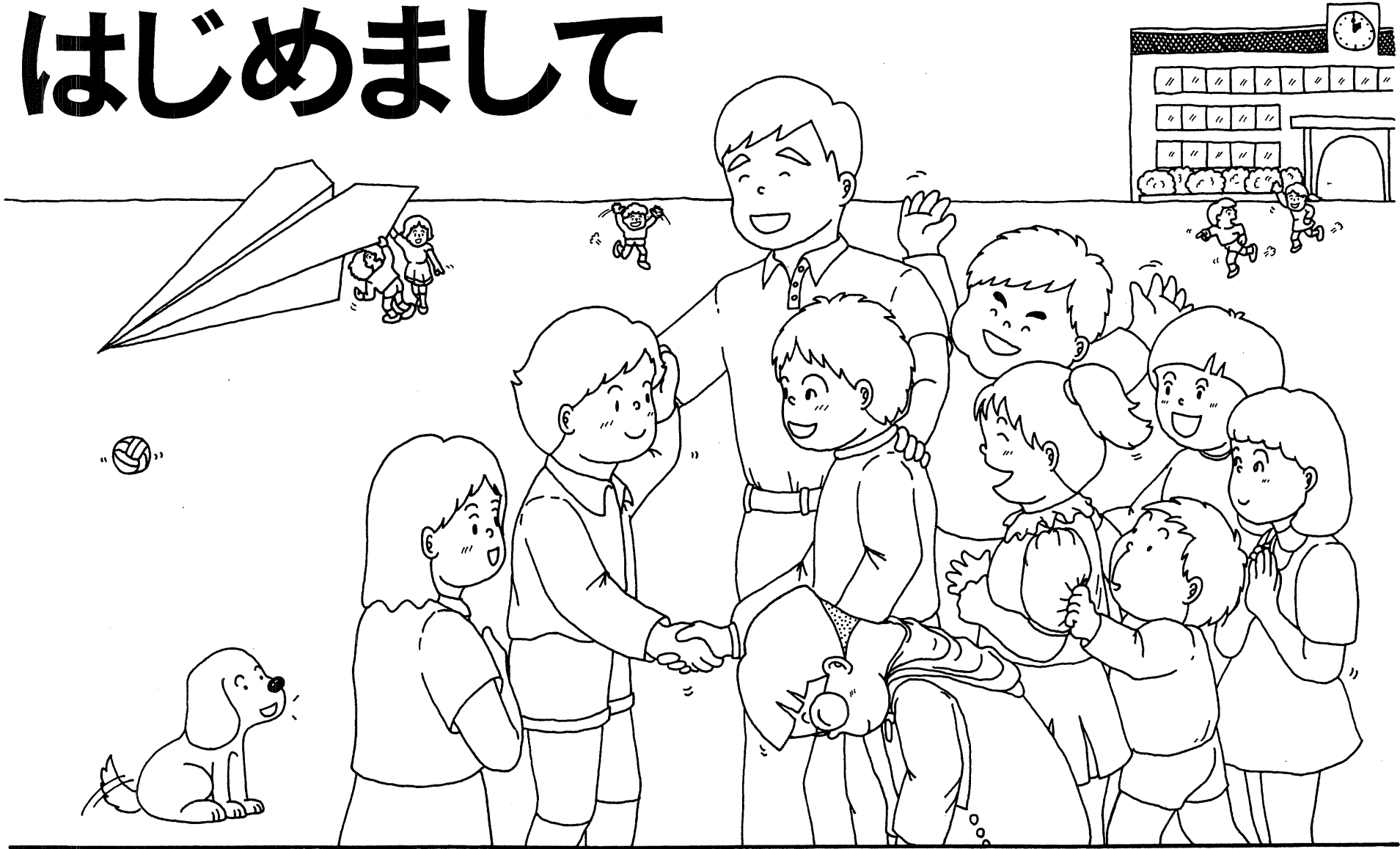

はじめまして

# あいさつ

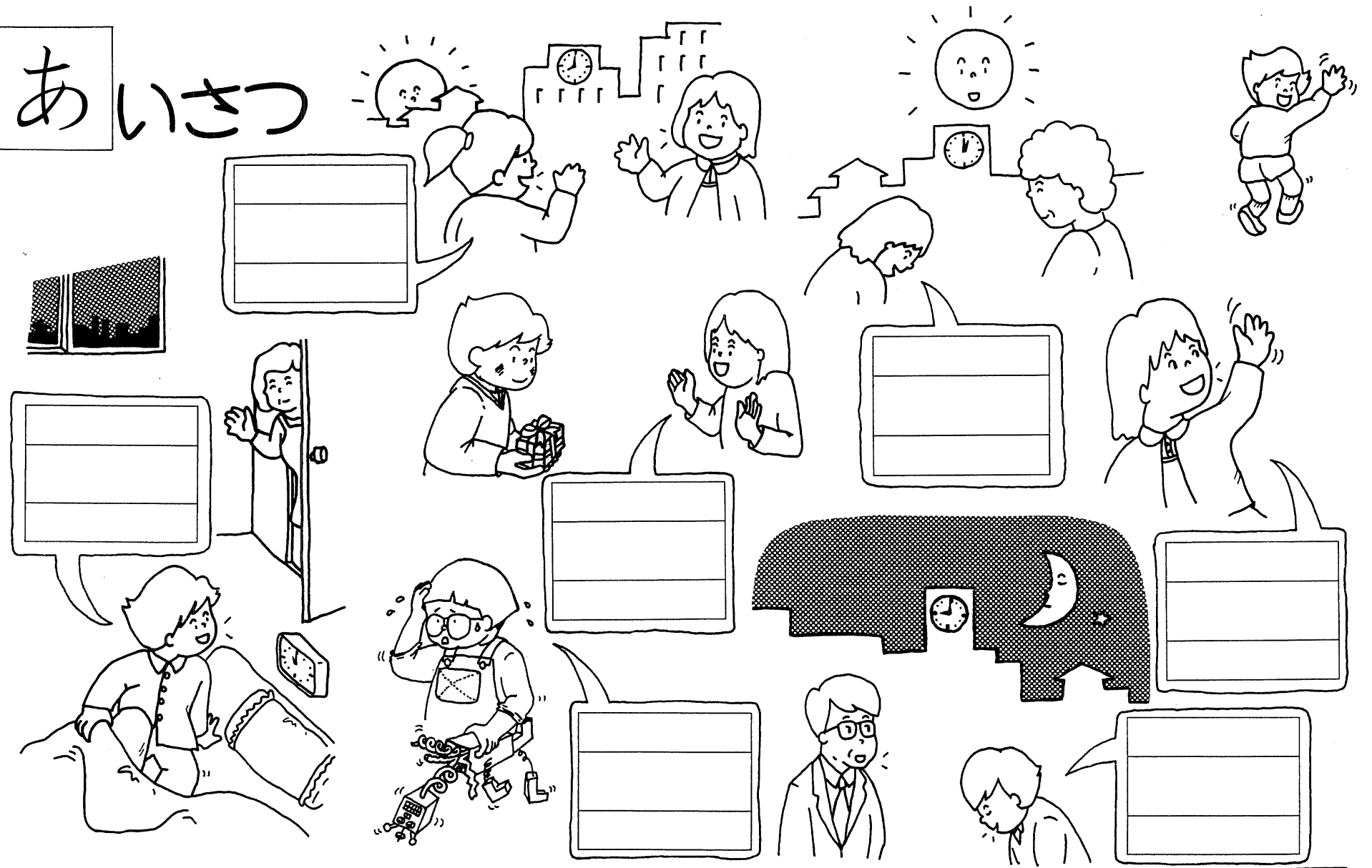

おはよう (ございます) こんにちは さようなら  
ありがとう (ございます)  
おやすみ (なさい) ごめん (なさい) こんばんは

あ	
ア	a

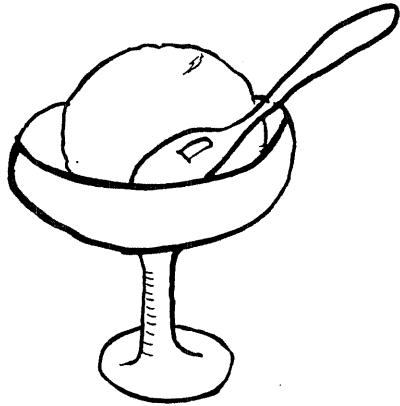

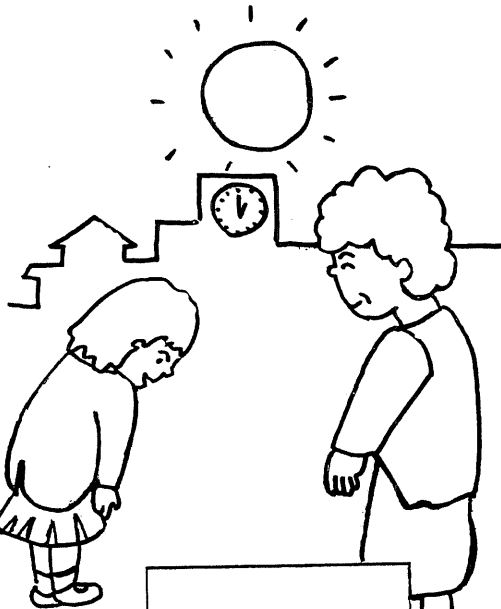

[あ.....]



[あ.....]



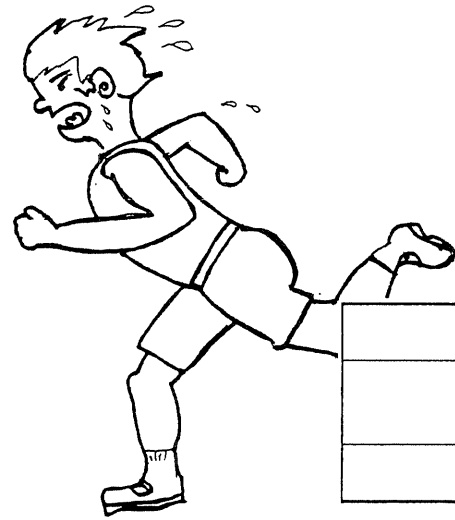

[あ.]

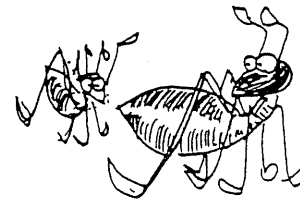

[あ.]

[あ.]



あいくりーむ [アイスクリーム]

あせ

あいさつ

あめ

あり



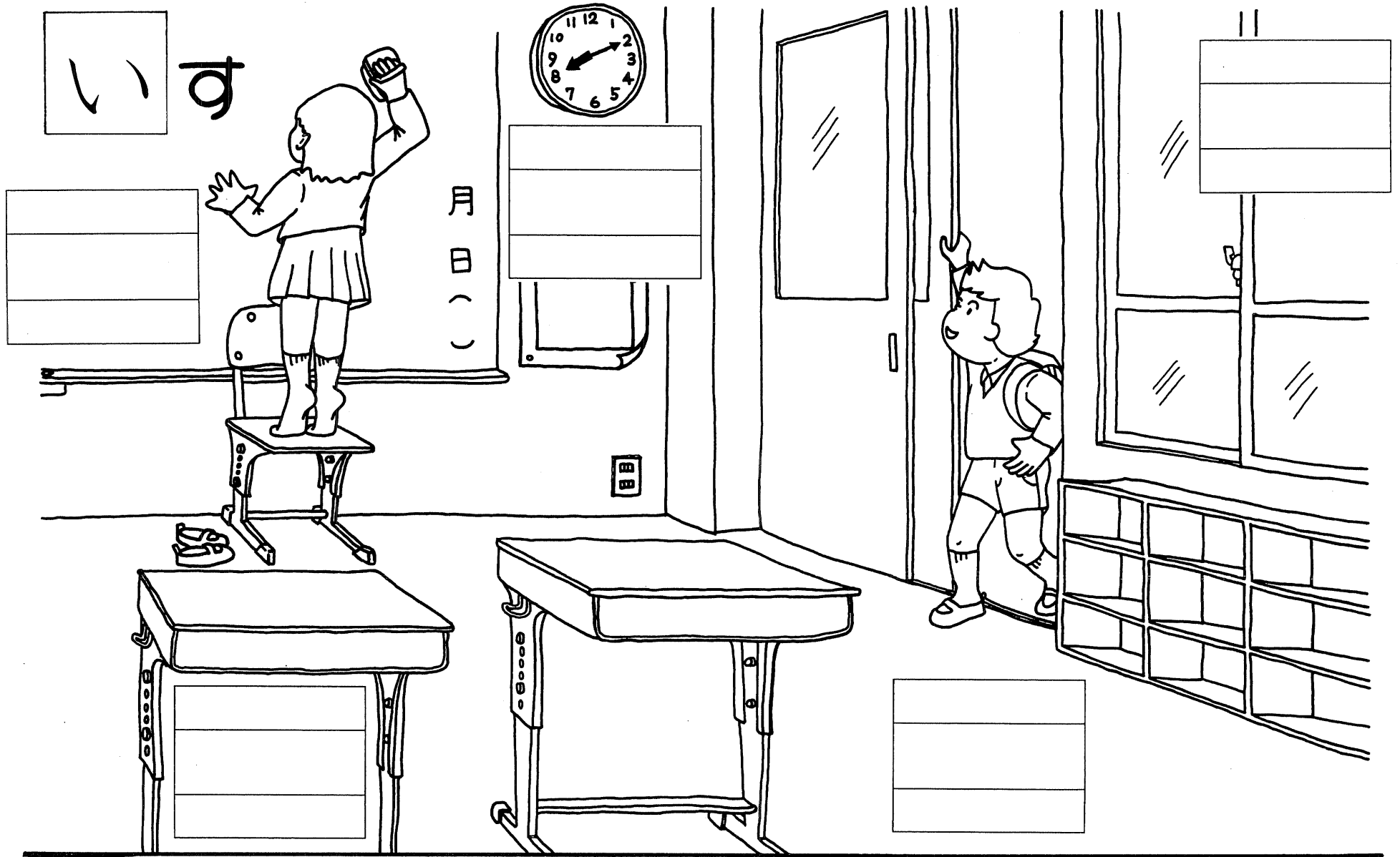

こくばん      とけい      まど  
 つくえ      ろっかー [ロッカー]

これは なにですか？  
 これは \_\_\_\_\_ です。

↙   ↘	
①   ②	
[ ]	
[ ]	[ ]
⋯	
イ	i

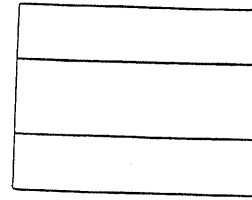
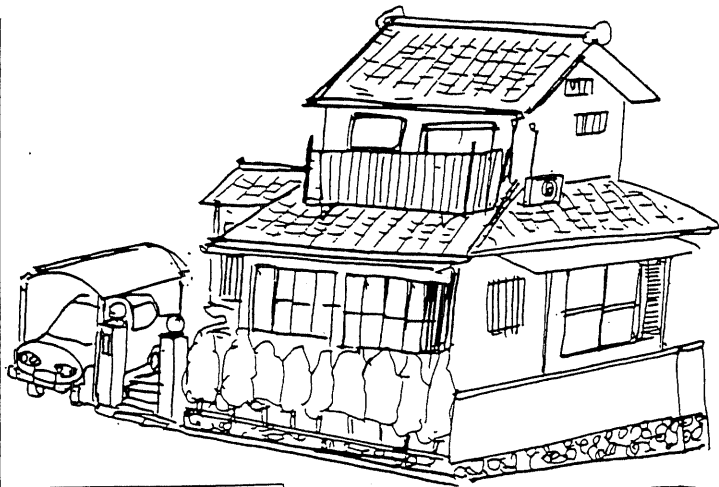

[い - ]

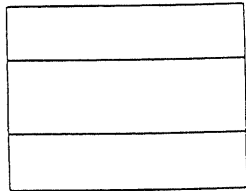
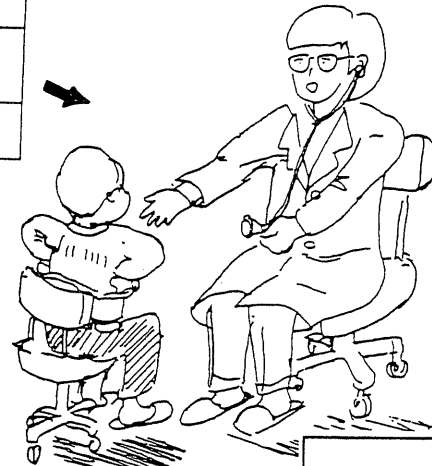

[い - ]

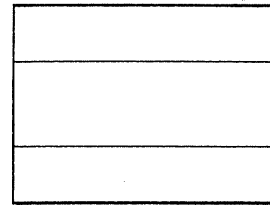
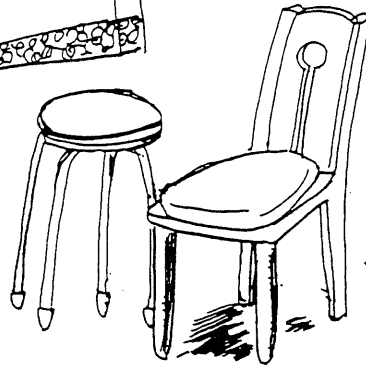
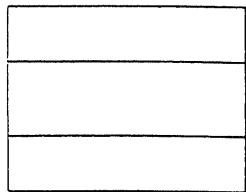

[い - ]

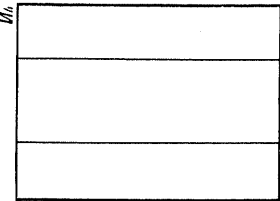

[い - ]

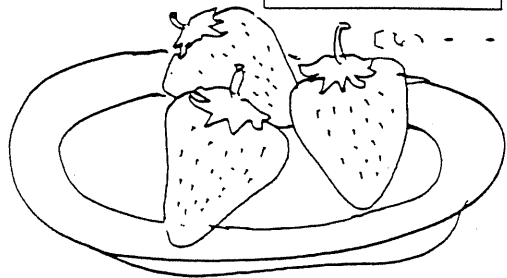

[い - - ]

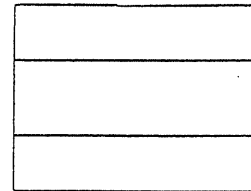
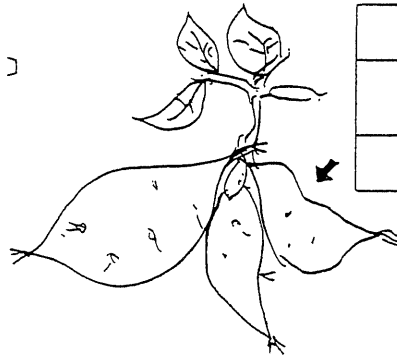

[い - ]

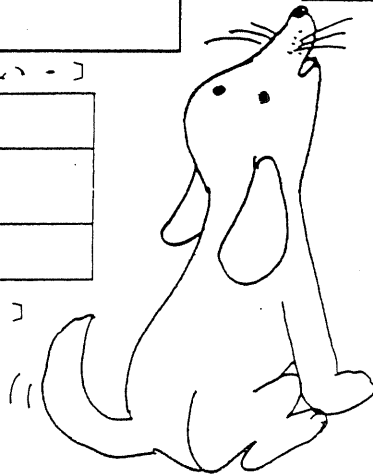

いえ

いしか

いす

いちご

いも

いぬ

# う んどうじょう

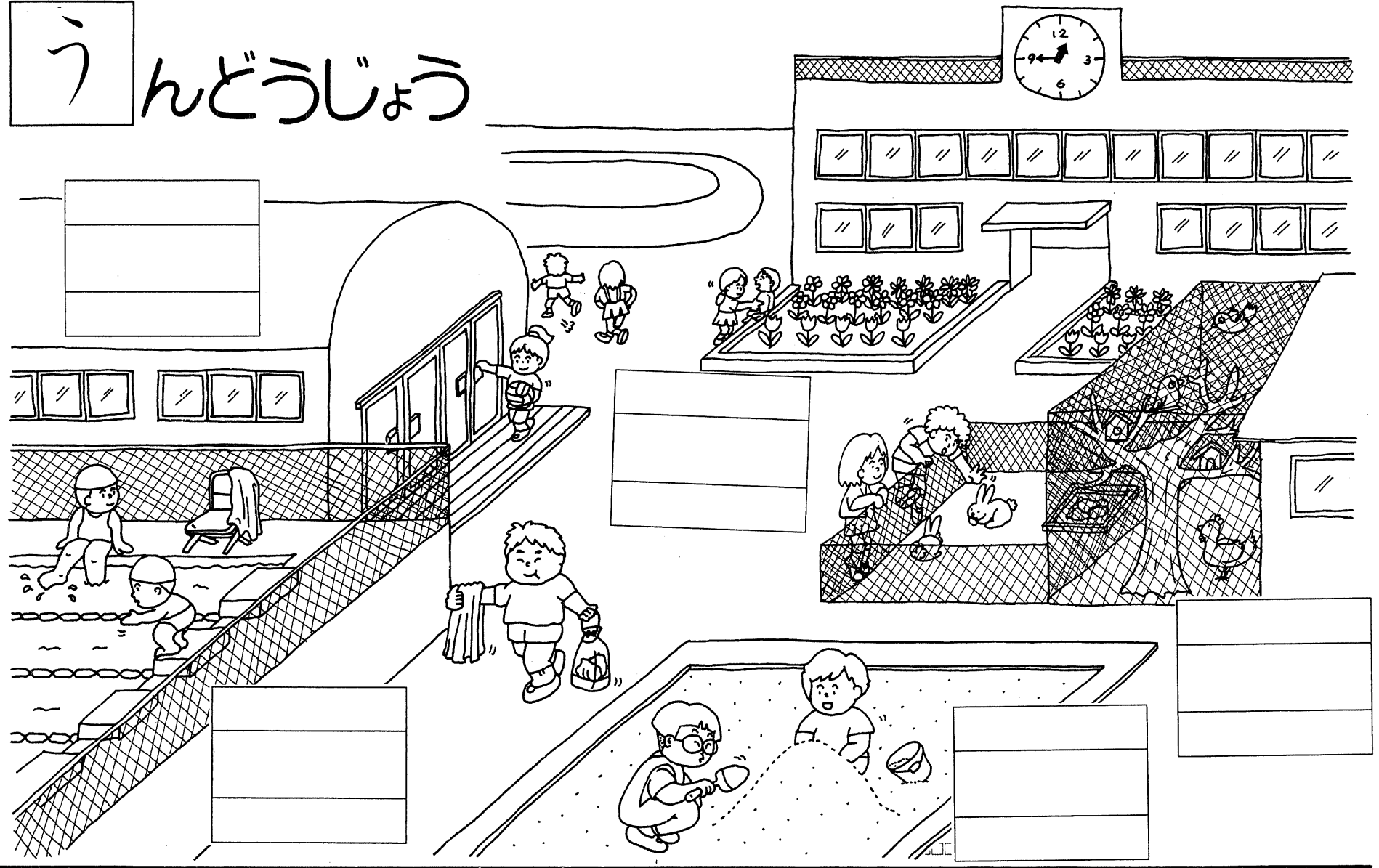

たいいくかん  
ぶーる (プール)

かだん  
すなば

しいくごや

あれ	は なにですか?	あれ	は — ですか。
それ		それ	

う	
①	②
う	
う	
ウ	u

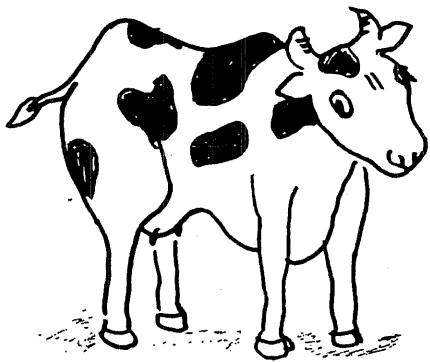

[う - - - -]

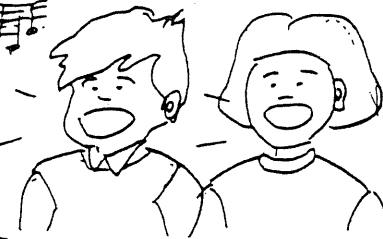
[う - ]

[う - ]

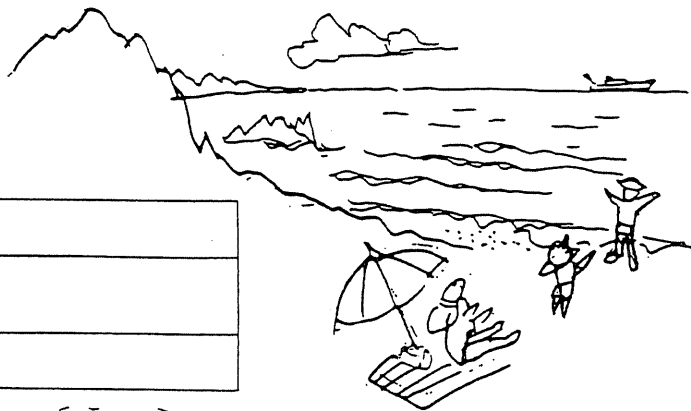
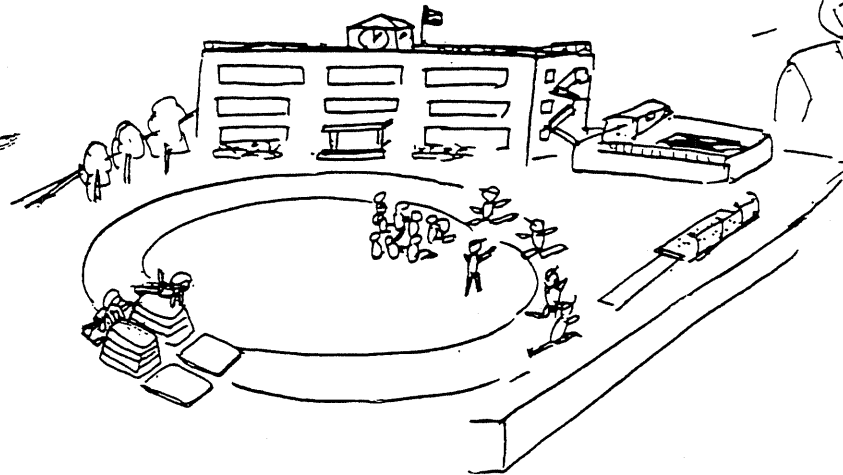

[う - ]

[う - - ]



うし

うた

うんどうじょう

うみ

うちわ

えんぴつ

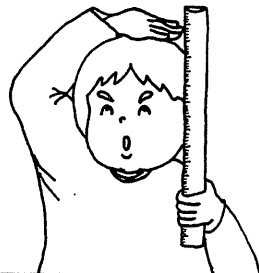
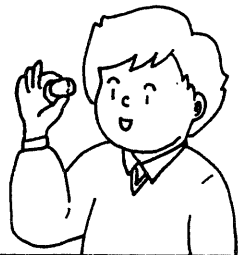
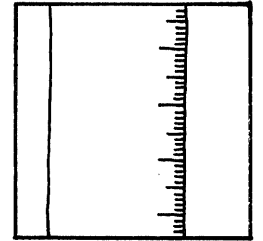
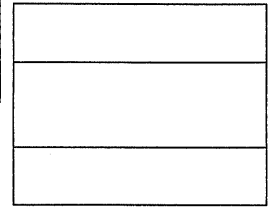
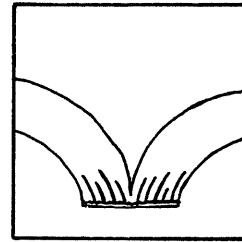
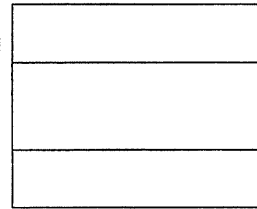
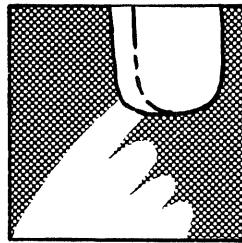
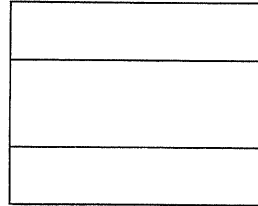
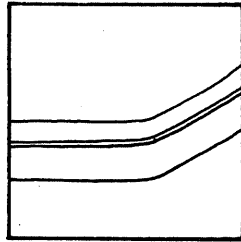
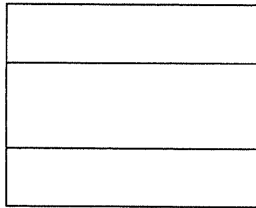
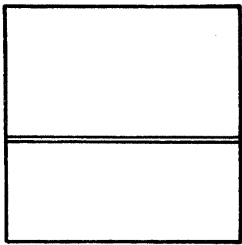
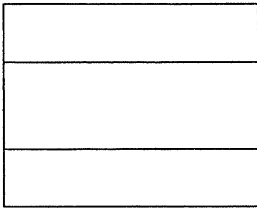
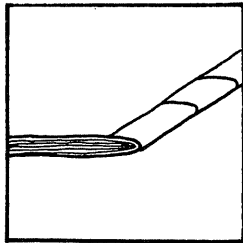
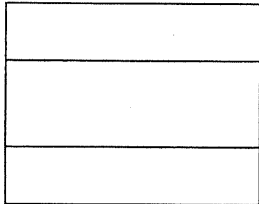
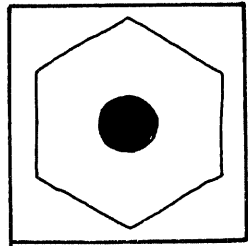

のーと(ー) したじき ふでばこ  
 けしごむ (けしご) きょうかしょ ものさし

これ | はい、 — ですか? はい、 — ですか。  
 あれ | いいえ、 — ではありません。  
 それ |

え	
② →	え
え	え
I	e

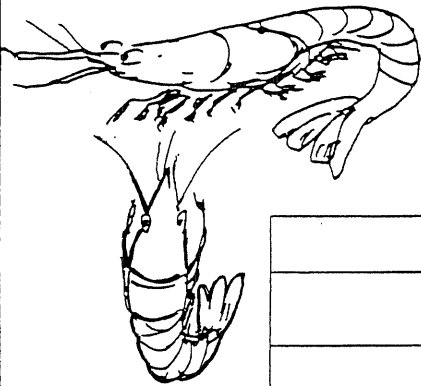

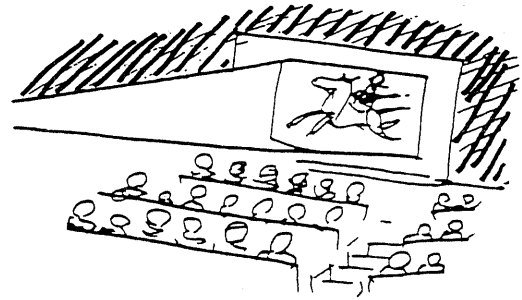

[元.....]



[元.....]

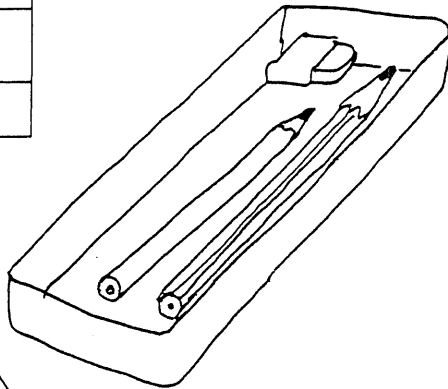

[元.]



[元.....]

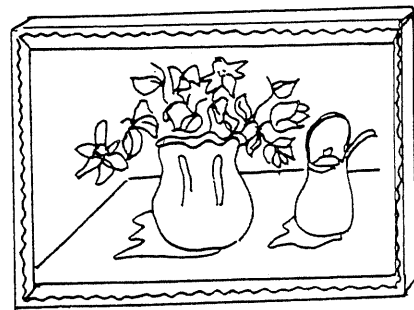

[元]



えび

えいが

えんぴつ

えんそく

え

# おなか

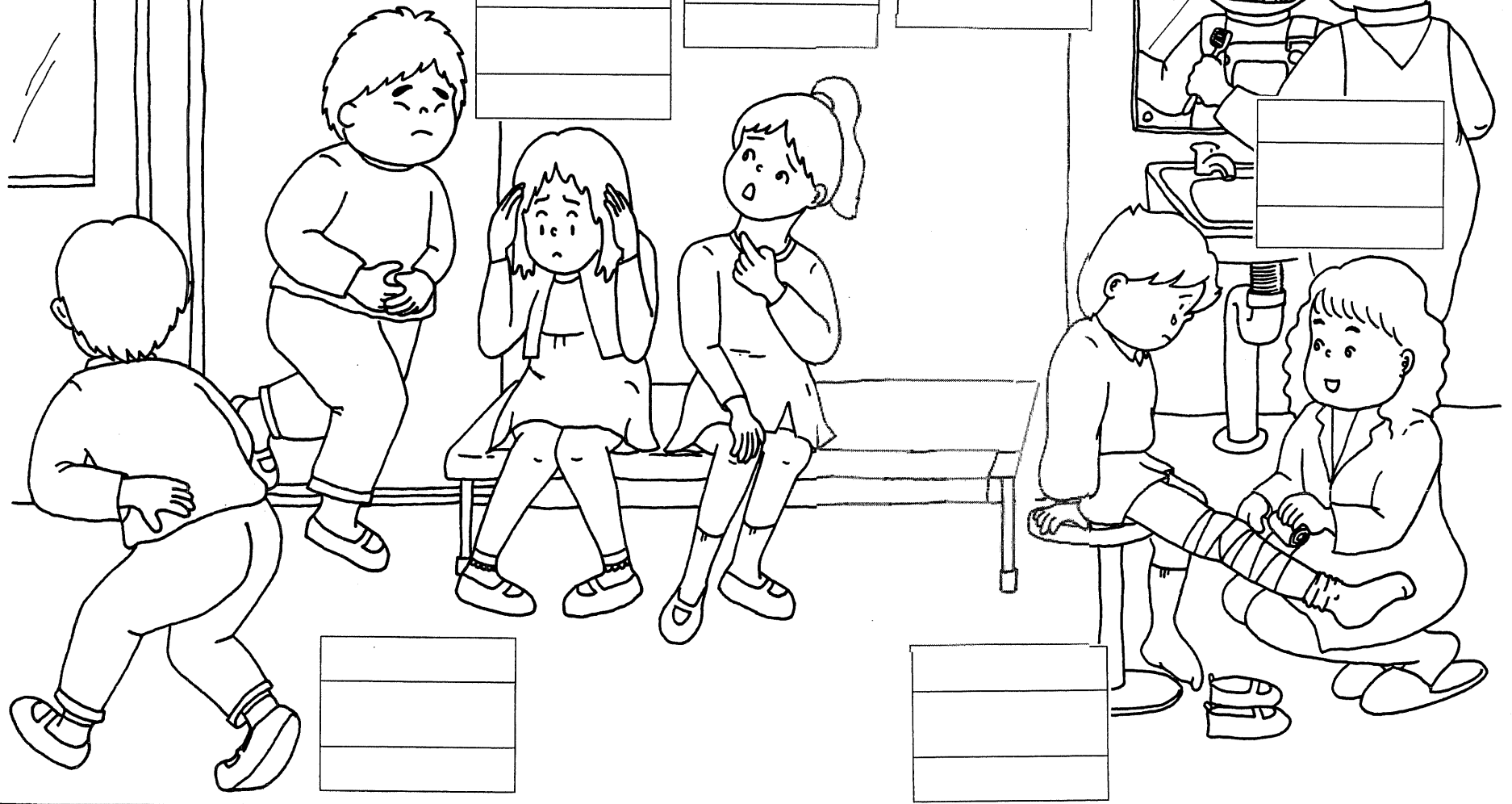

あたま くび むね は  
こし あし

どこが いたいですか？  
—— が いたいです。

お

お

お

お

お

オ

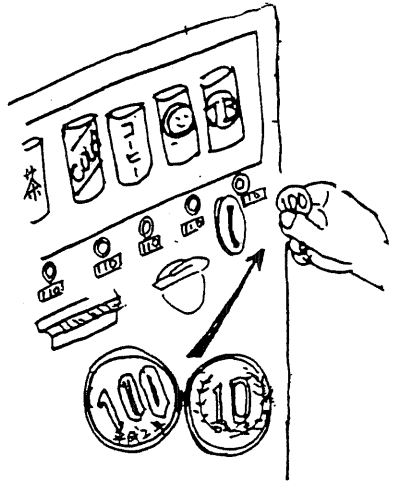

[お...]

[お...]

[お...]

[お...]

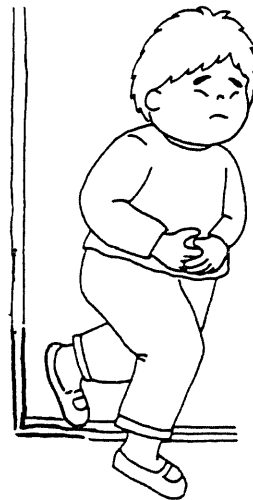
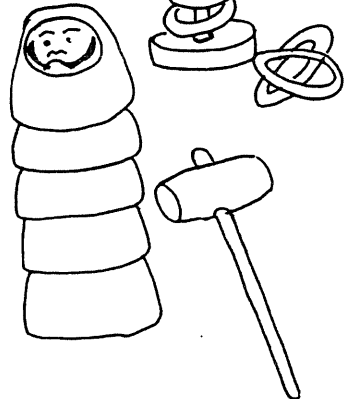

[お...]

[お...]

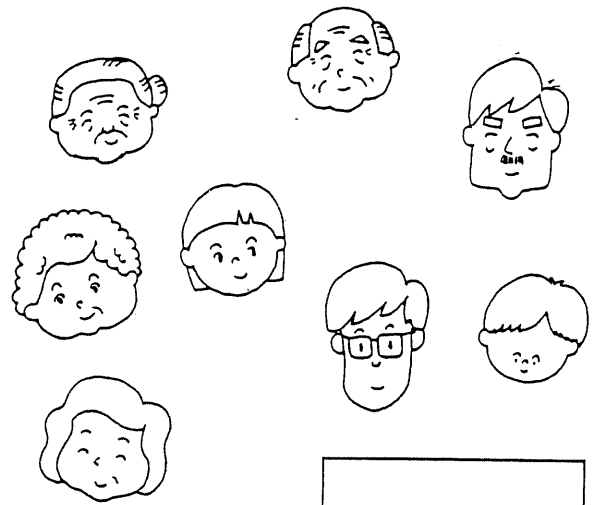

[お...]

[お...]

おかね

おんな

おとこ

おもちゃ

おなか



かぞく

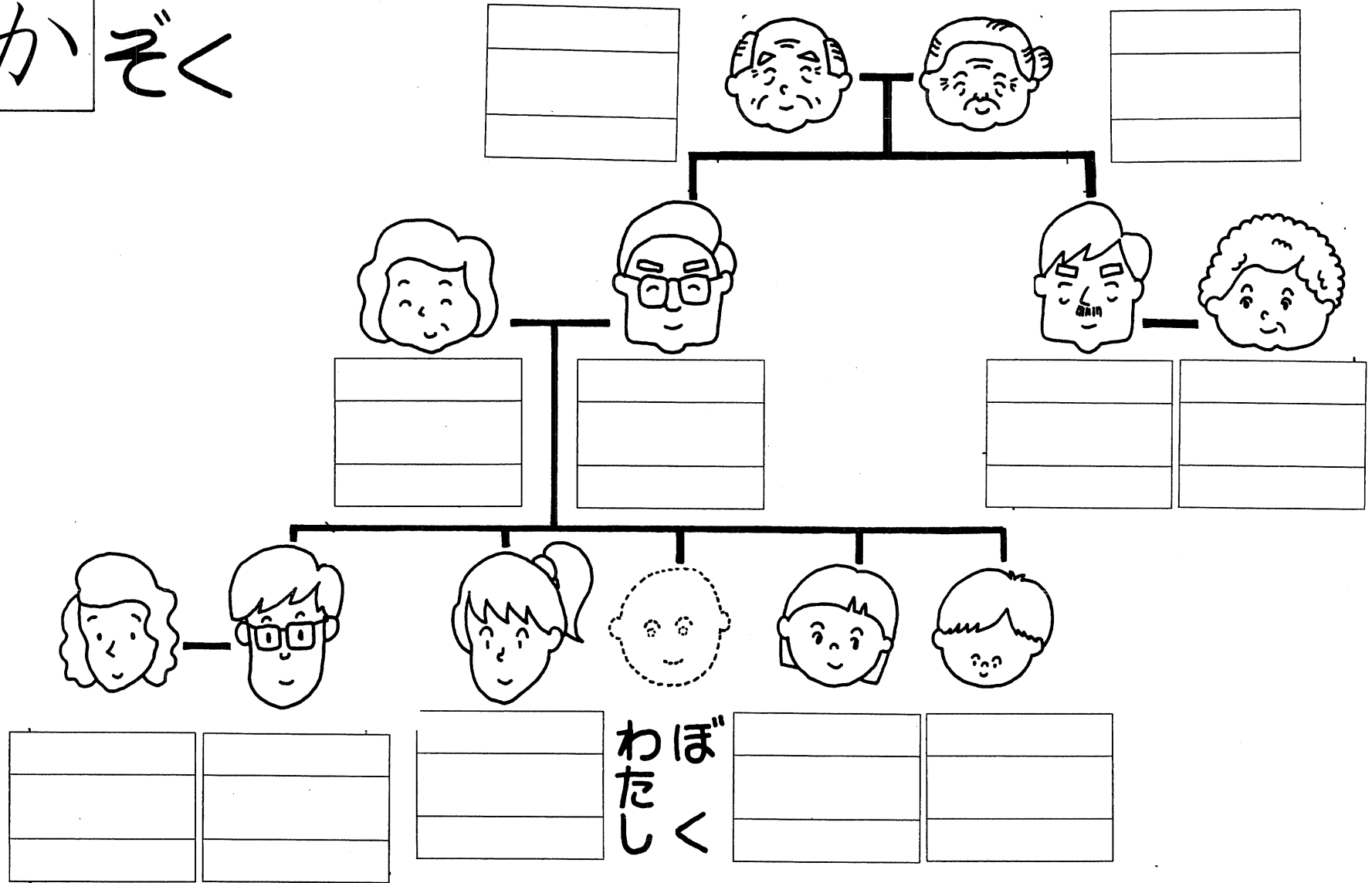

おじいさん おばあさん  
 おかあさん おとうさん おじさん おばさん  
 おねえさん おにいさん おねえさん いちろう おとうと

<発音>  
 おじさん おじいさん  
 おばさん おばあさん

か

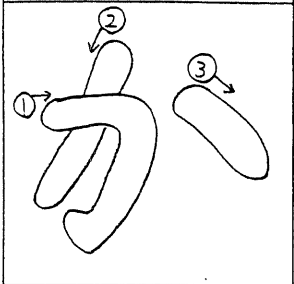

[か - ]

が か

[か - (ひき)]

①カ ka

ガ ga

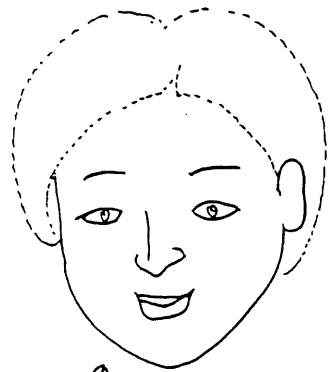

[か - ]

[か - ]



[か - (ひき)]

[か - (ひき)]

かお  
かぜ (ひき)

かぞく

[か - ]

[か - ]

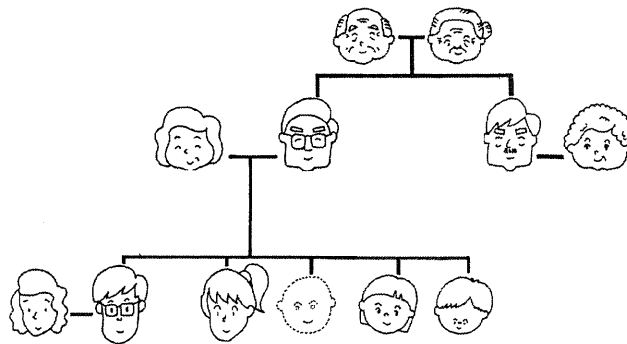

わぼ  
たく

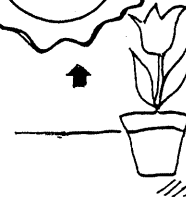
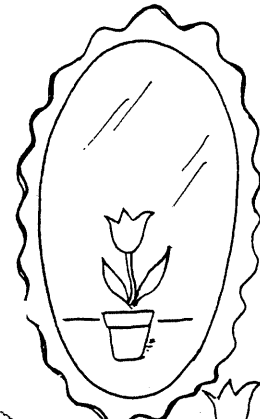

[か - ]

[か - ]

[か - ]

[か - ]

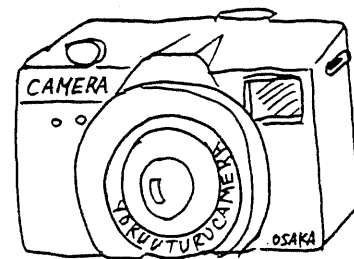

かがみ  
かめら (カメラ)

# ま ようしつ

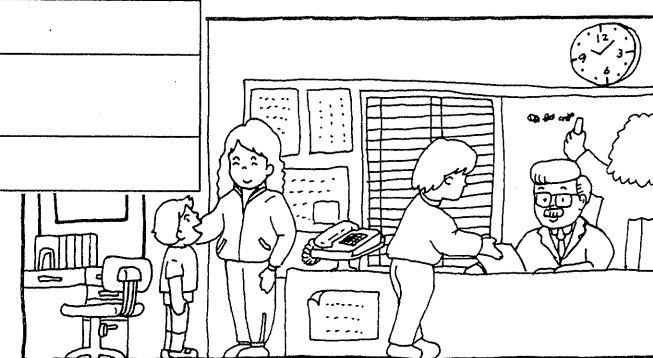
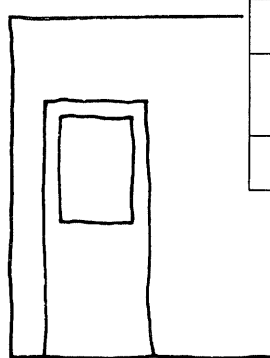
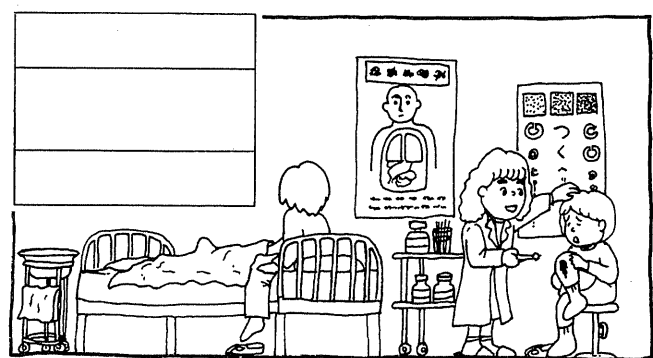
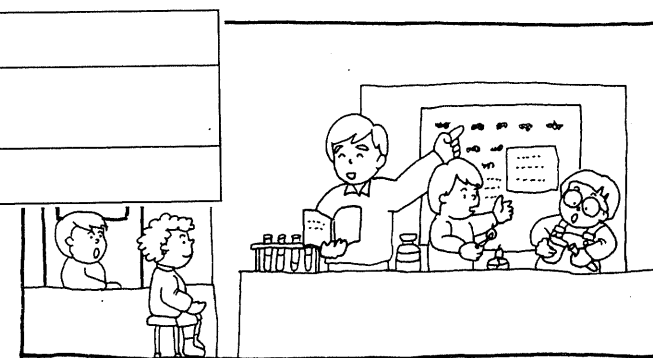
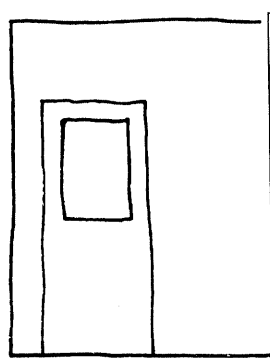
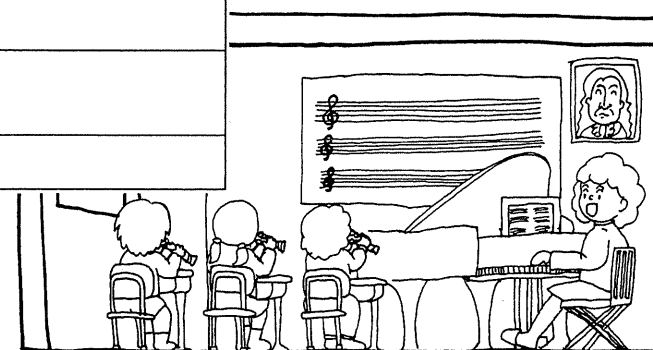
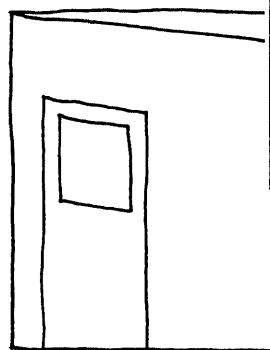
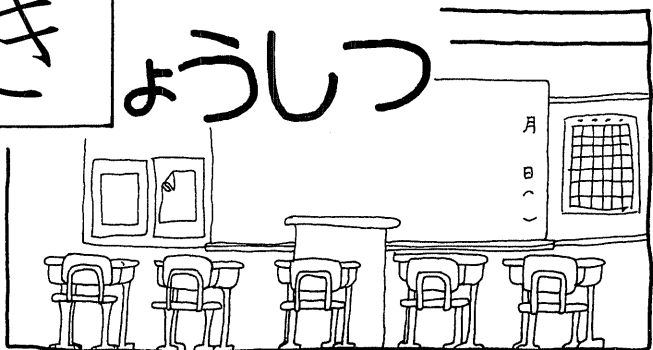

としょしつ  
ほけんしつ

おんがくしつ  
りかしつ  
しょくいんしつ

ここは \_\_\_\_\_ です。  
あそこ

キ

③  
①  
②  
④

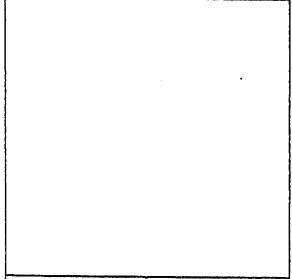

ギ

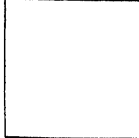

キ

ki

ギ

gi

キ	(キ)	Kya
キ	(キ)	Kyu
キ	(キ)	Kyo
ギ	(ギ)	Gya
ギ	(ギ)	Gyu
ギ	(ギ)	Gyo

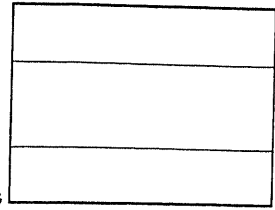
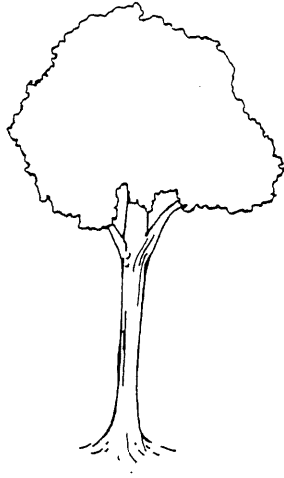

[キ]

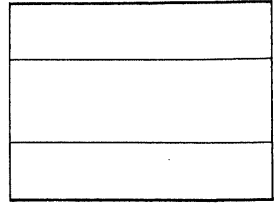

[キょう...]

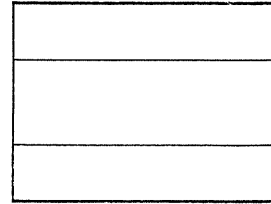
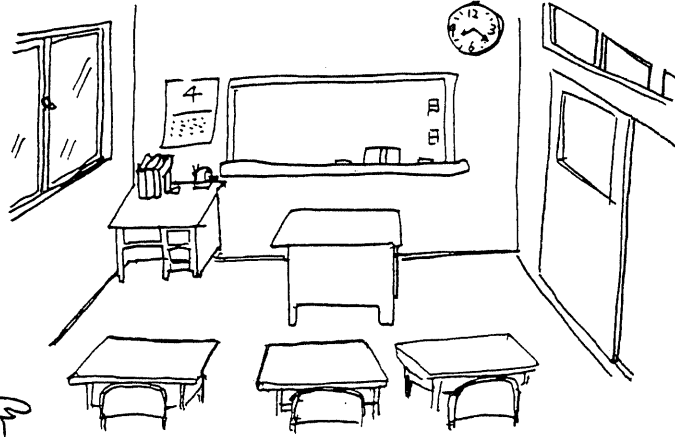

[キゅう...]

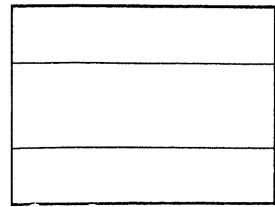

[キ...]

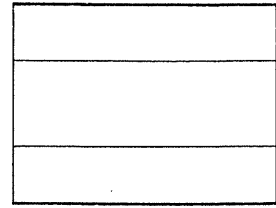

[キ...]

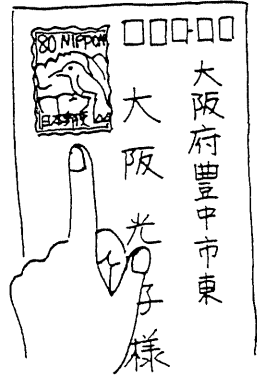

教室  
教室のもの

きょうしつ

きゅうしよく

きって

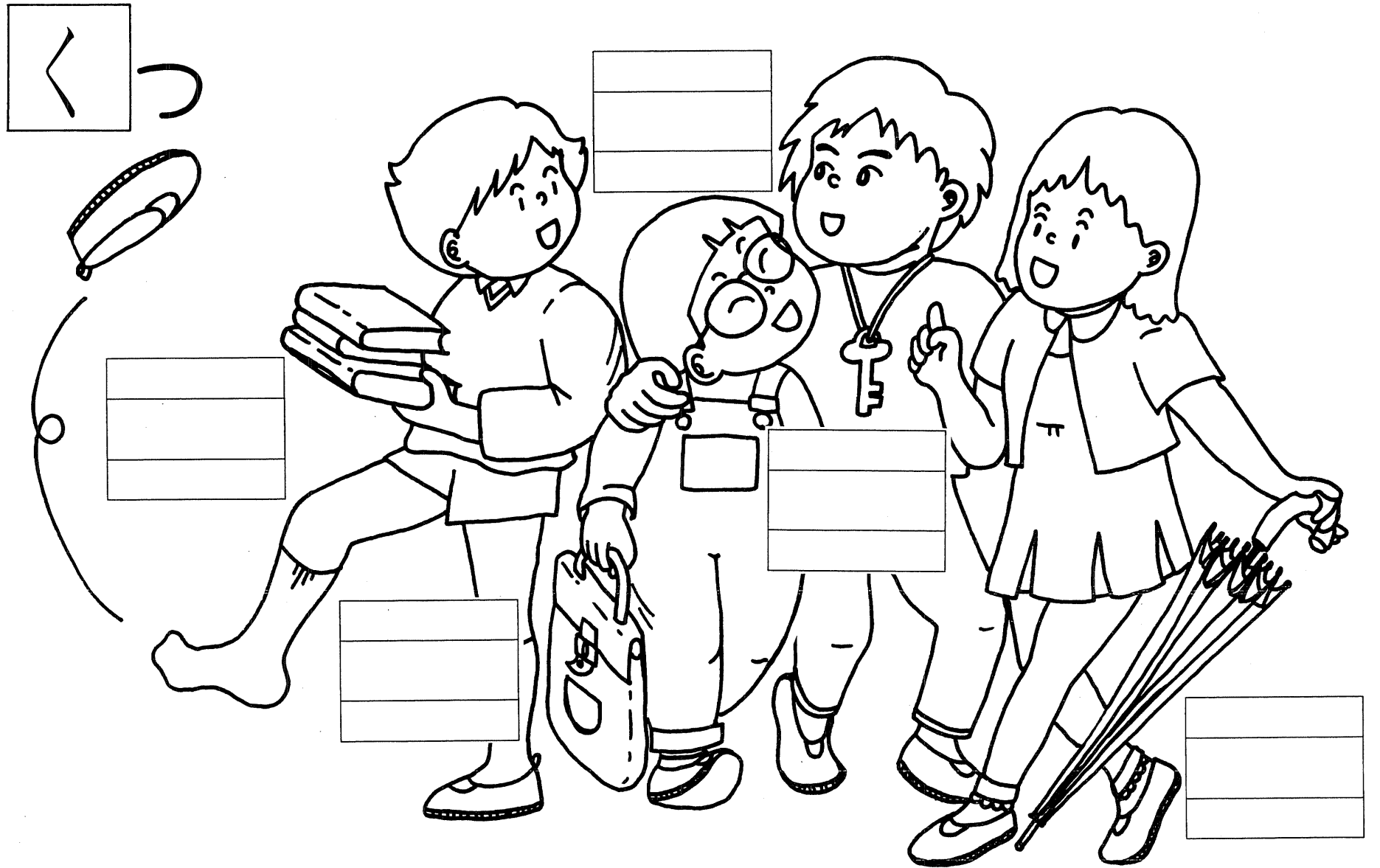

ほん

めがね

かぎ

かばん

かさ

があります。  
 — と — があります。

<	
<	
<	
<	<
ク	ku
グ	gu

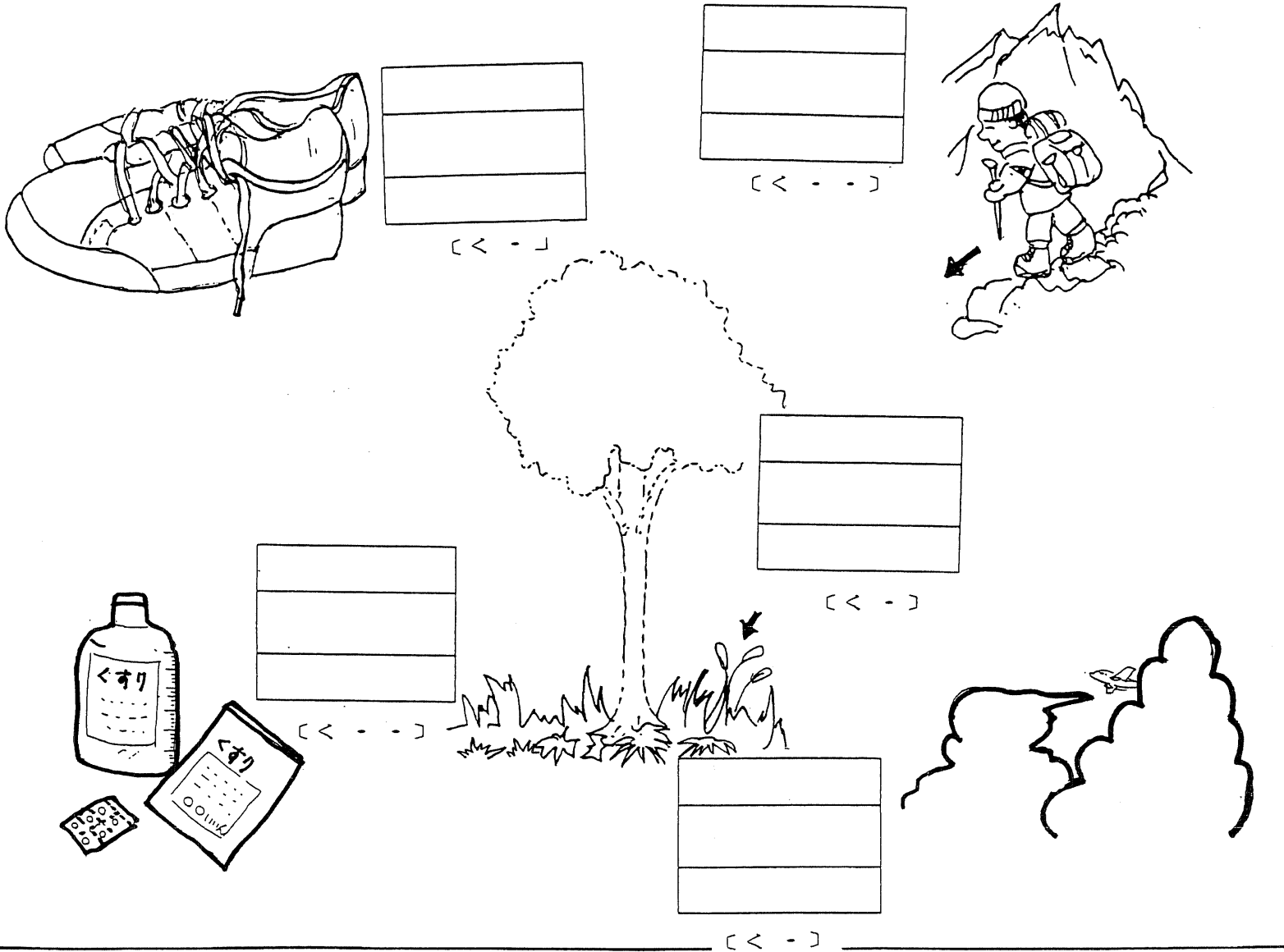

<つ	<さ	<だり
<すり	<さ	<も

# げんかん

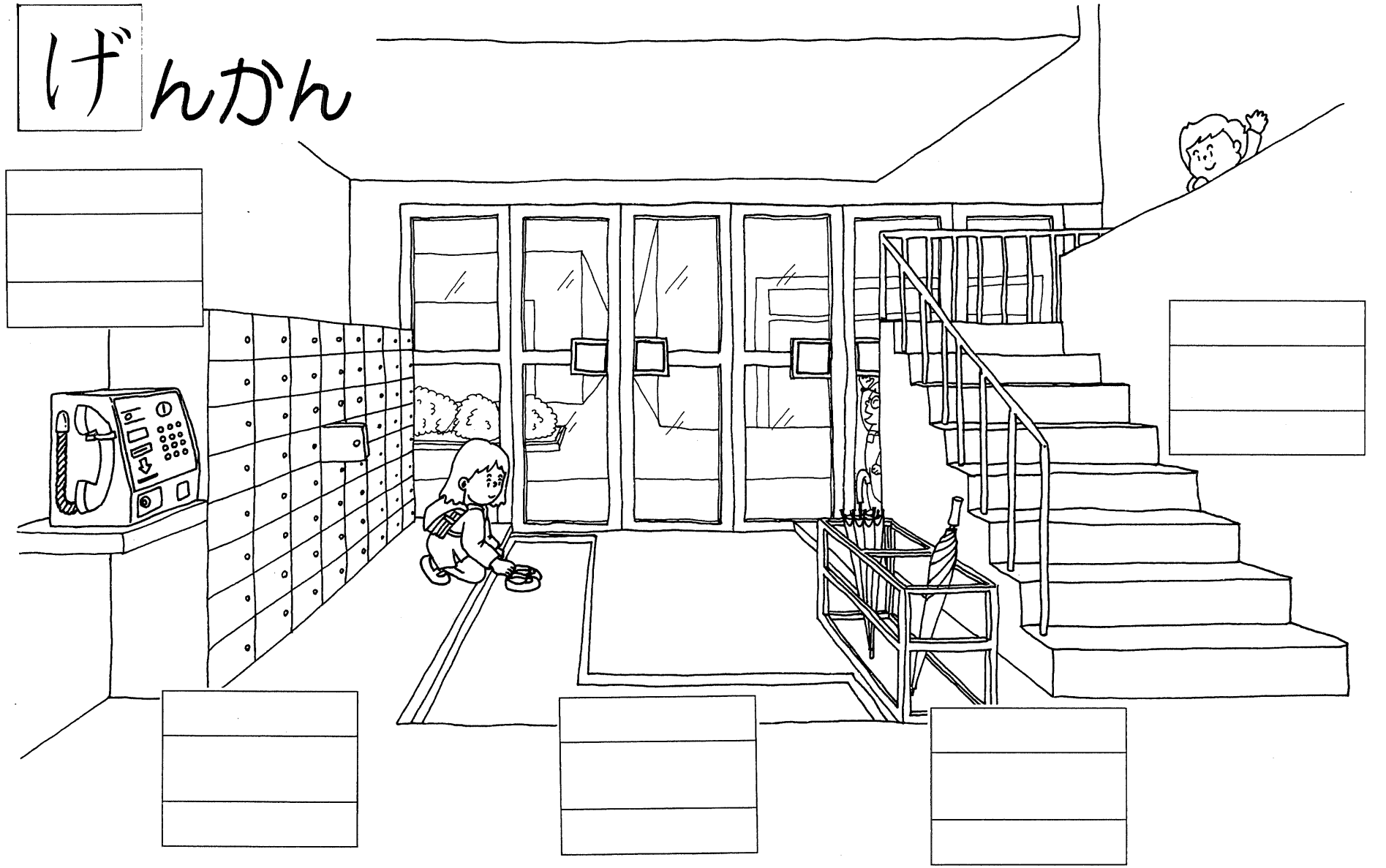

でんわ      くつばこ      かいだん  
 まつと(ワット)      かさたて

ここに ———— があります。  
 あそこ      そこ

け

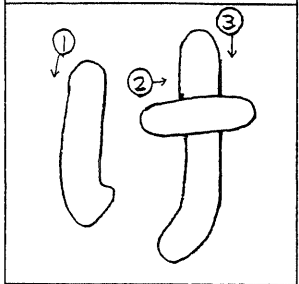

Blank space for writing practice.

げ け

Blank space for writing practice.

ケ ke

ゲ ge

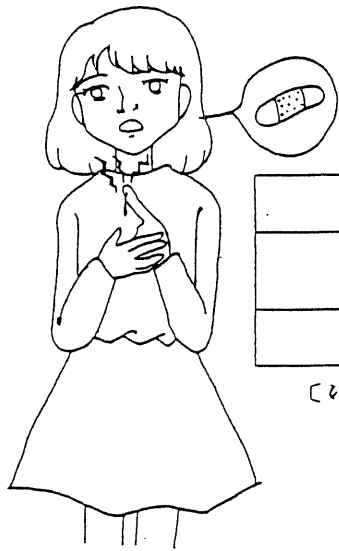

Blank writing box with three horizontal lines.

[け - ]

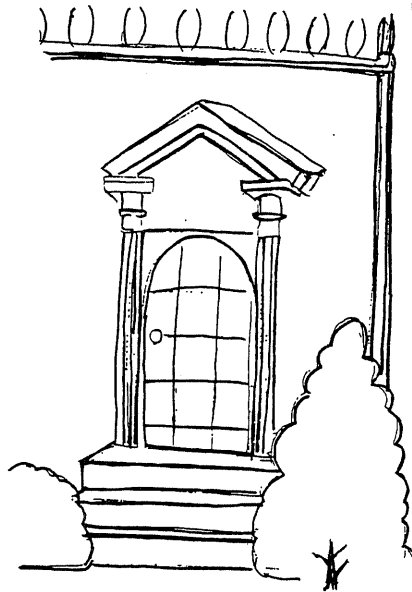

Blank writing box with three horizontal lines.

[げ - - - ]

Blank writing box with three horizontal lines.

[け - - ]

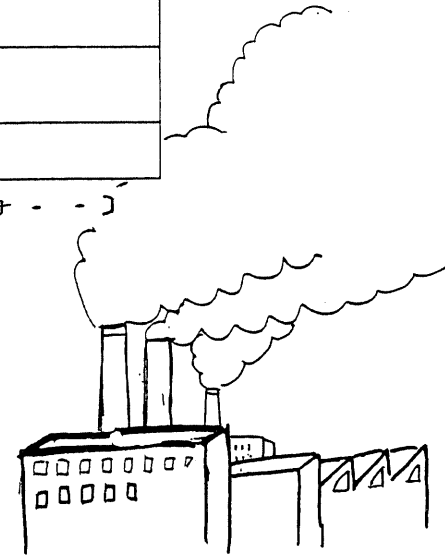

Blank writing box with three horizontal lines.

[け - - ]



けが

けむり

げんかん

けんか

ケーキ [ケ-キ]



こ

く

月

火

水

木

金

土

1

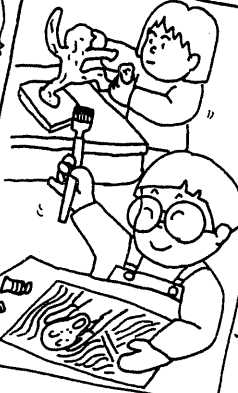
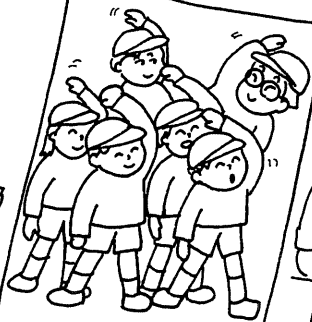

2

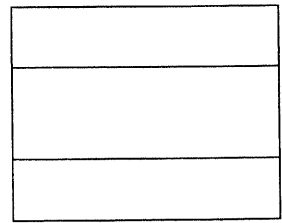
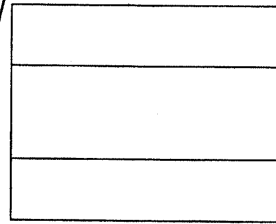
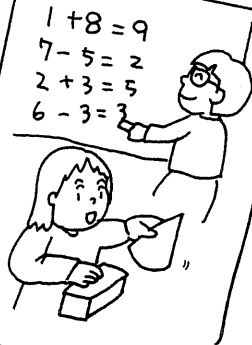
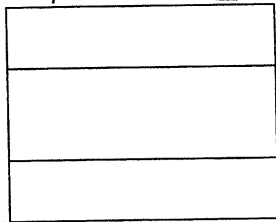
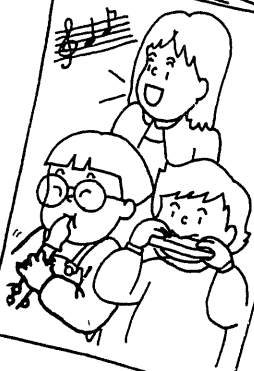

たいいく りか ずこう しゃかい  
おんがく さんすう

は やさしい ます。  
むずかしい  
たのしい





[こ..]



[こ...]

こめ

こっぷ (コップ)

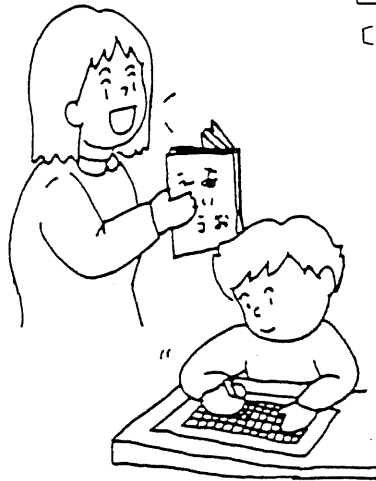



[こ...]

こんぴゅーた (コンピュータ)

こくご

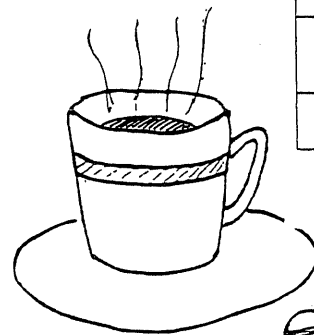
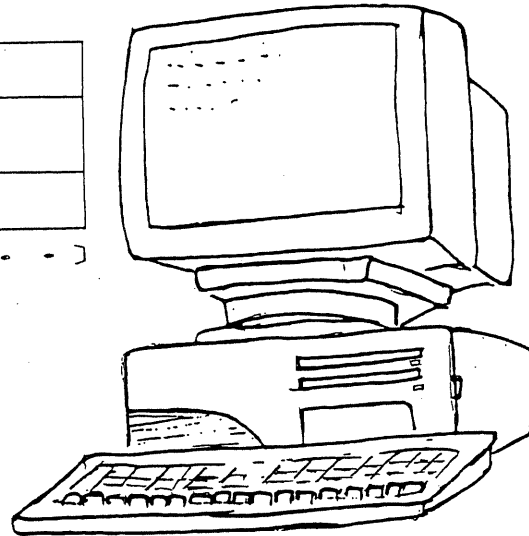
[こ...]





[こ...]

こーひー (コーヒー)

サ

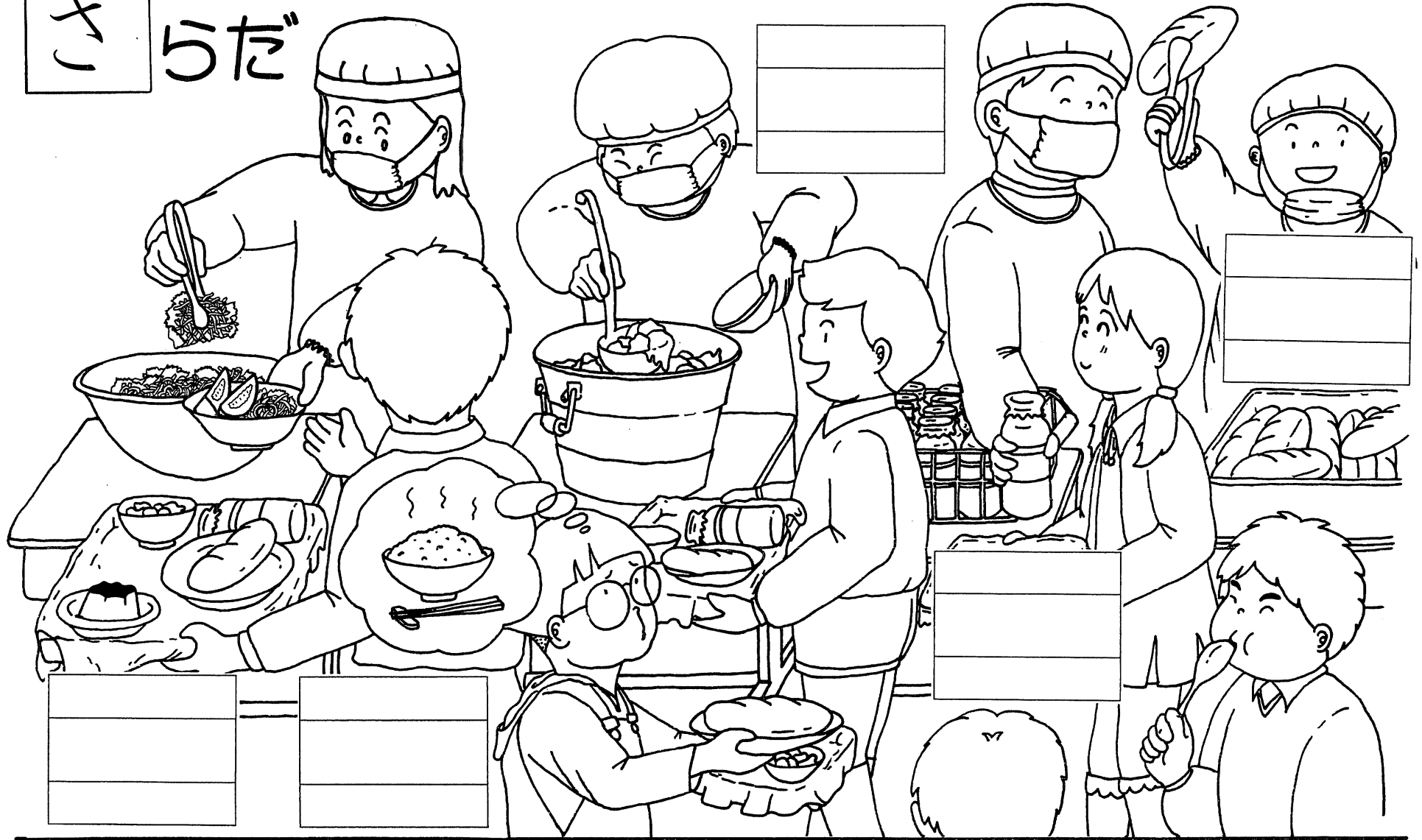
らだ



おかず

ばんぱん

でぎーと (デザート) ごはん

ぎゅうにゅう

——が すきです。

サ

① ② ③

サ

さ

サ sa

ザ za

Blank writing box with three horizontal lines

[サ - -]

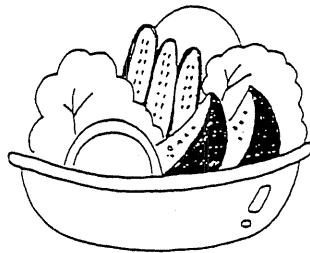

Blank writing box with three horizontal lines

[サ - -]

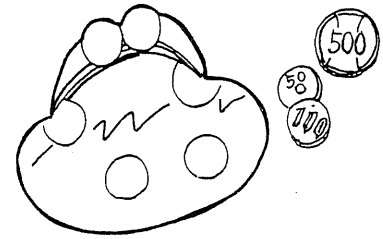
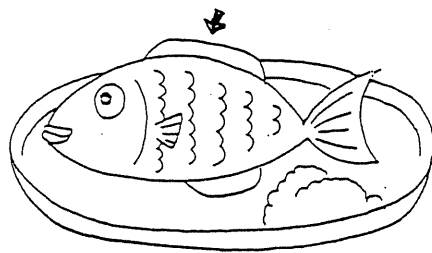

Blank writing box with three horizontal lines

[サ - -]

Blank writing box with three horizontal lines

[サ -]

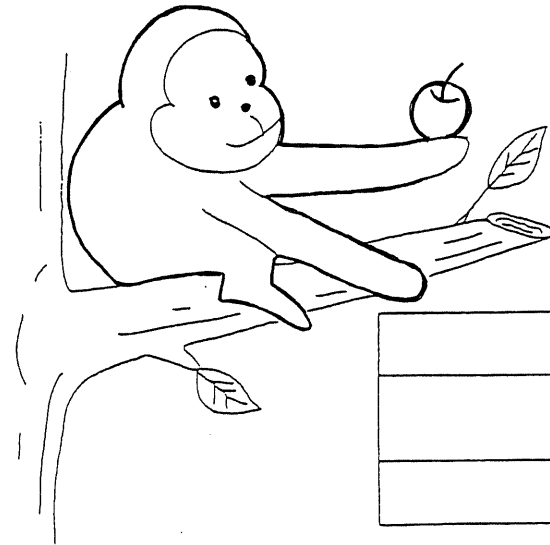
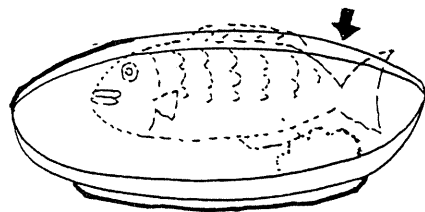

Blank writing box with three horizontal lines

[さ -]

さらだ (サラダ)

さら

さかな

さいふ

さる

しあい

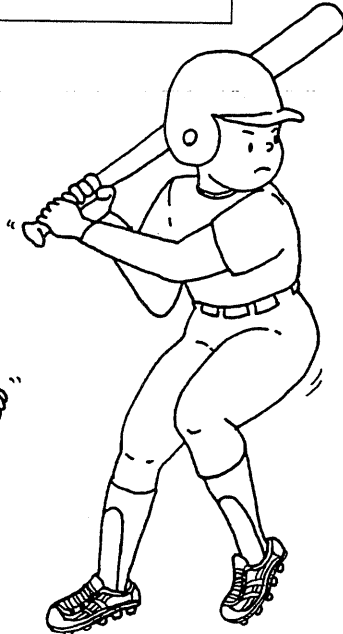
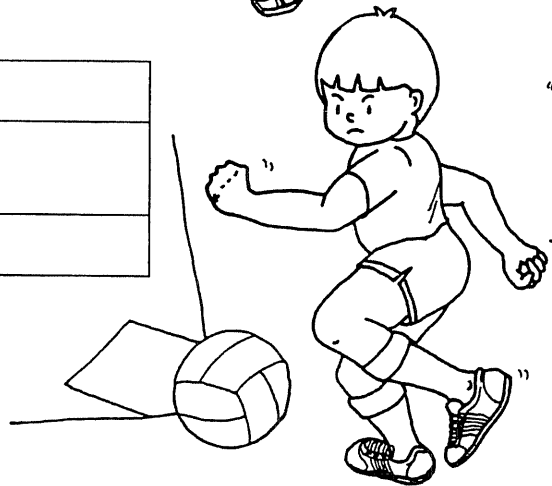
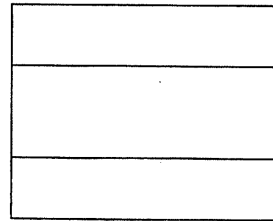
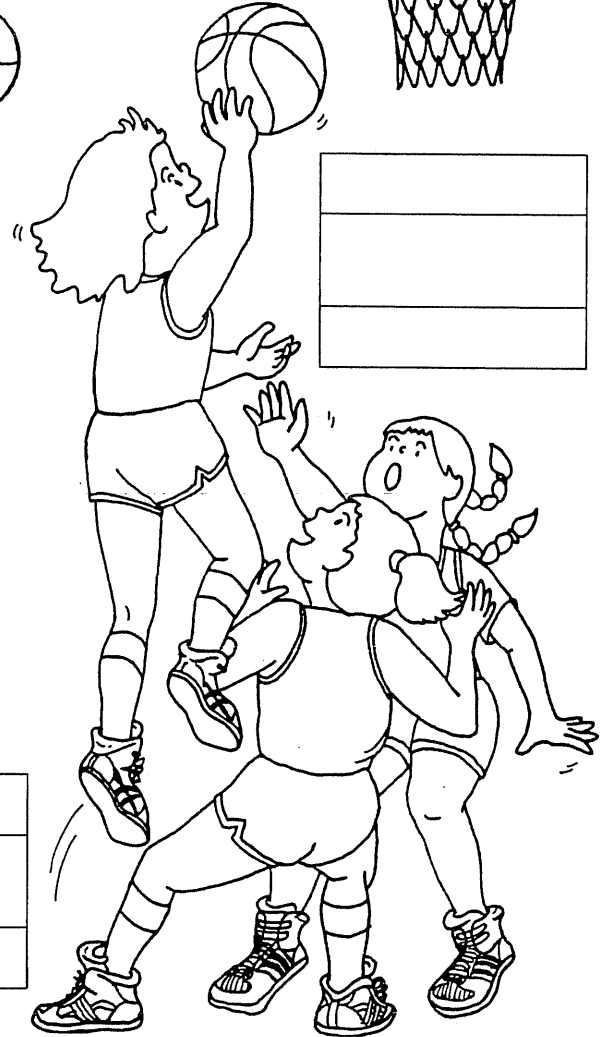
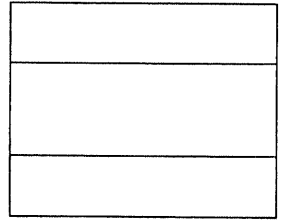
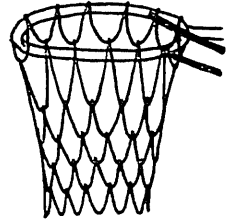
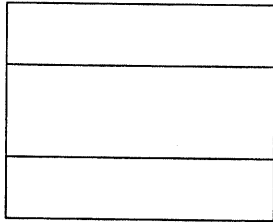
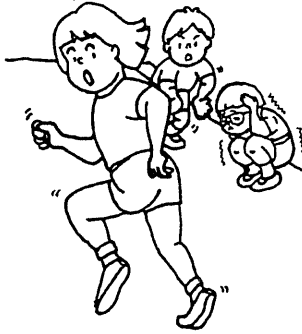
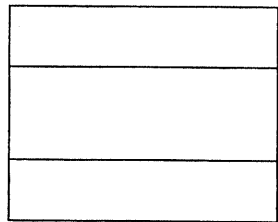
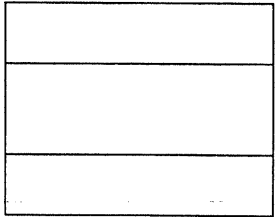

きッカー どっじぼーる  
[サッカー] [ドッジボール]

ばすけっとぼーる  
[バスケットボール]

きっくべーすぼーる  
[キックベースボール]

やきゅう

——が できますか？

はい、できます。  
いいえ、できません。

し

し

じ し

シ si

ジ zi

しゃしん  
しんぶん

じてんしゃ

じゃんけん  
しあい

しゃ (シャ)	nya
しゅ (シュ)	nyu
しょ (ショ)	nyo
じゃ (ジャ)	zya
じゅ (ジュ)	zyu
じょ (ジョ)	zyo

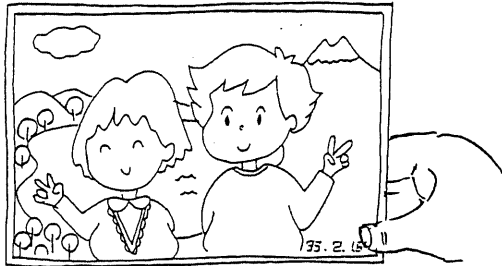

Blank writing box with three horizontal lines.

[しゅ - - -]

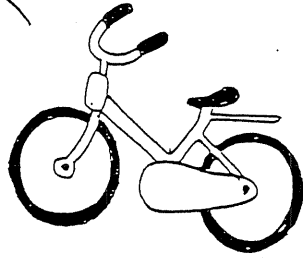

Blank writing box with three horizontal lines.

[じゅ - - -]

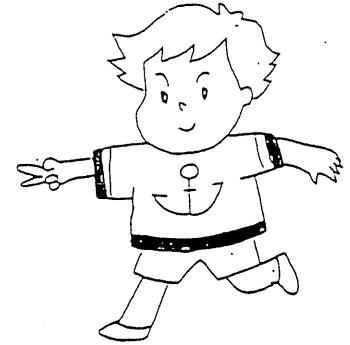

Blank writing box with three horizontal lines.

[じゃ - - -]



Blank writing box with three horizontal lines.

[しん - - -]

Blank writing box with three horizontal lines.

[しゃ - - -]



すうじ

1

2

3

4

5

6

7

8

9



10

いち に さん し(よん) ご  
ろく しち(なな) はち きゅう(く) じゅう

<発音>

じゅう — じゅう きゅう — きゅう

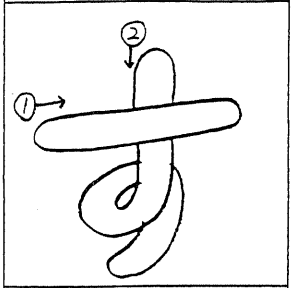
す



す

ず す

ズ zu

ズ zu

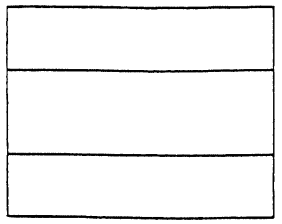
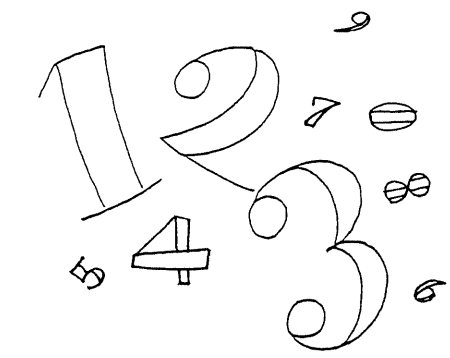

[す...]

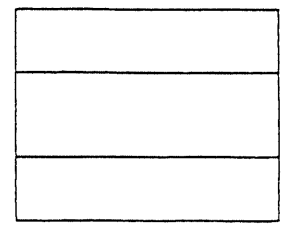
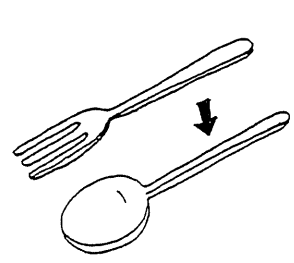

[す...]

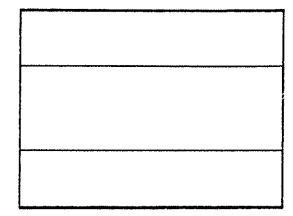
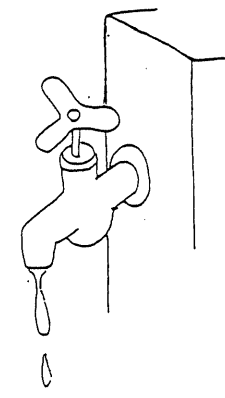

[す...]

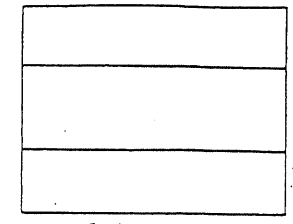

[す...]

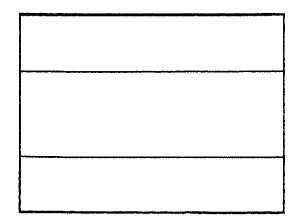

[す...]

すうじ すいどう すいえい  
すぷーん (スプーン) すぽーつ (スポーツ)



せんち

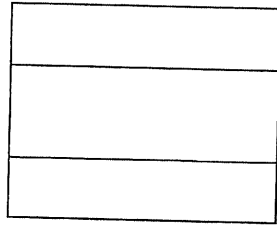

dL

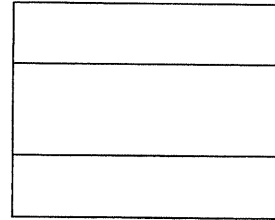

g

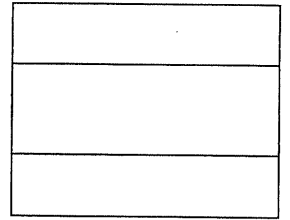

cm

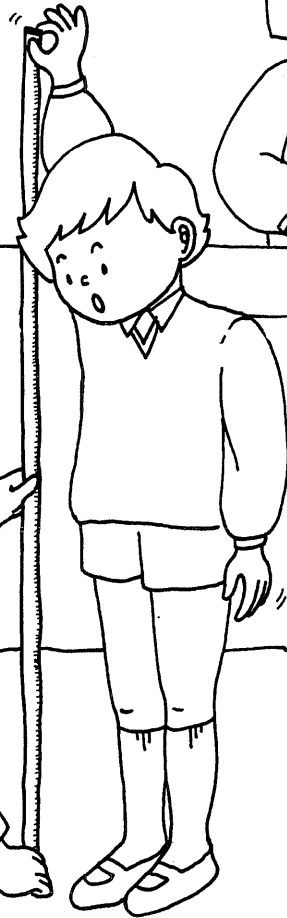

m



L

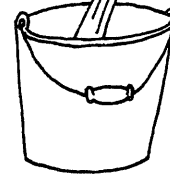

kg

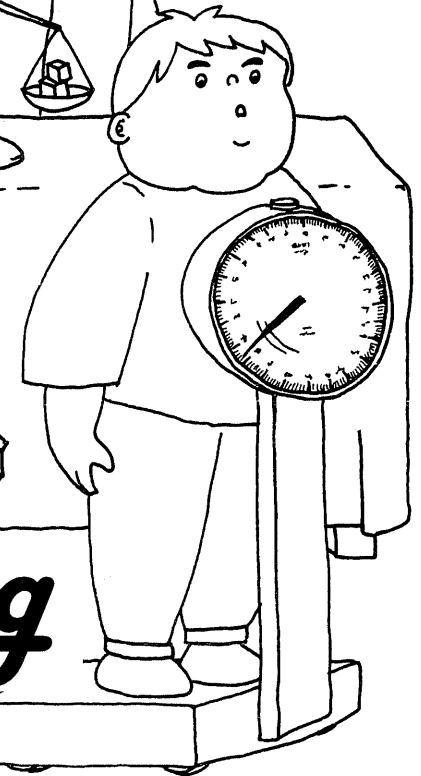

でしりっとる (デシリットル)    ぐらむ (グラム)  
めーとる (メートル)    りっとる (リットル)    きろぐらむ (キログラム)

<発音>  
りっとる    りとる  
めーとる    めとる

せ	
<div style="border: 1px solid black; height: 40px; width: 100%;"></div>	
せ	せ
<div style="border: 1px solid black; height: 40px; width: 100%;"></div>	
せ	se
せ	ze

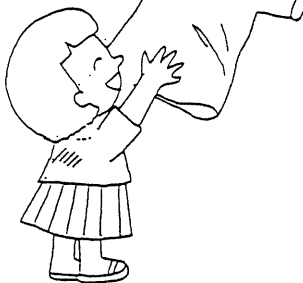
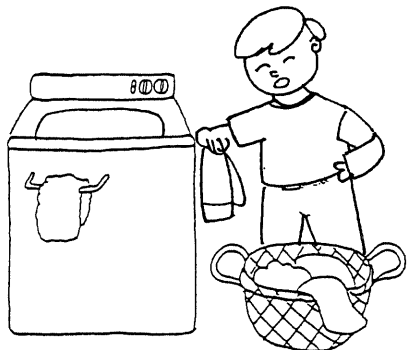
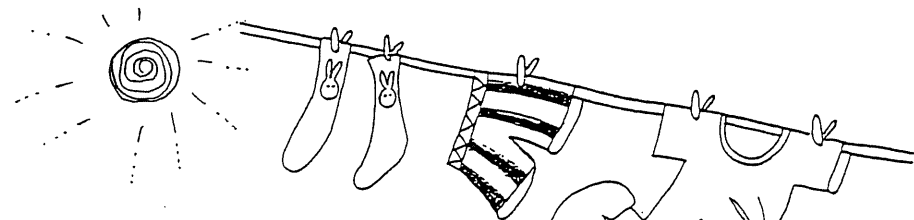

6月21日

[せ.....]

[せ.....]

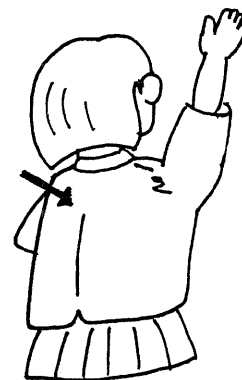

[せ.....]

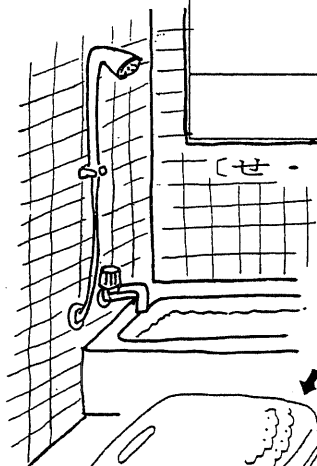

[せ.....]

[せ.....]



せんたく  
せっけん

せなか

せんせい  
せんち (センチ)

と

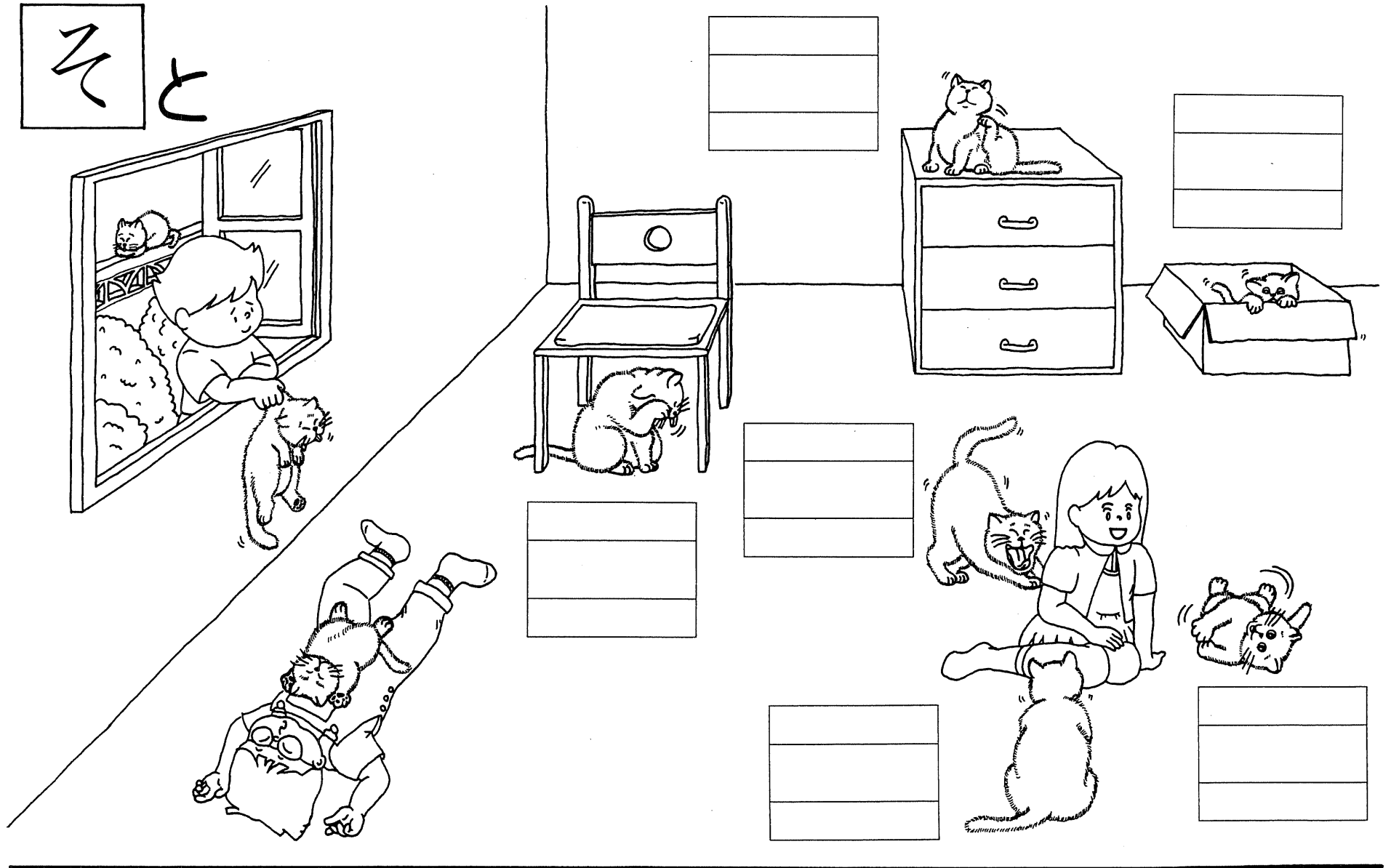

した

うえ

なか

まえ

よこ

そ	
①	↓
↓	
↓	
そ	そ
ソ	SO

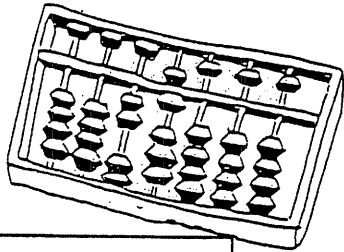

[そ.....]

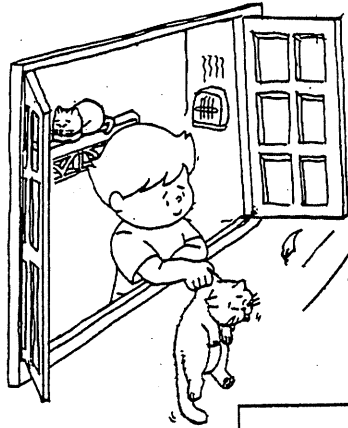

[そ.]

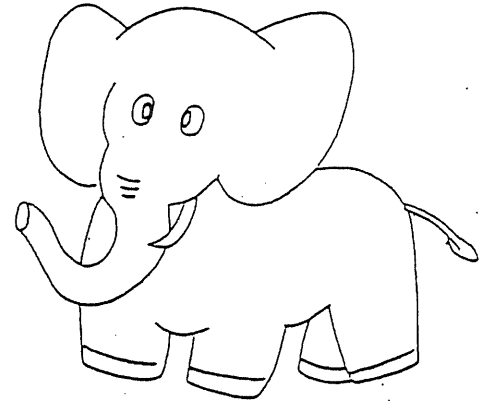

[ぞ.]



[そ.]

[そ...]





[そ.....]



ソ	ZO
---	----

そろばん      そと      ぞう  
 そら  
 そふとくりーむ (ソフトクリーム)      そうじ

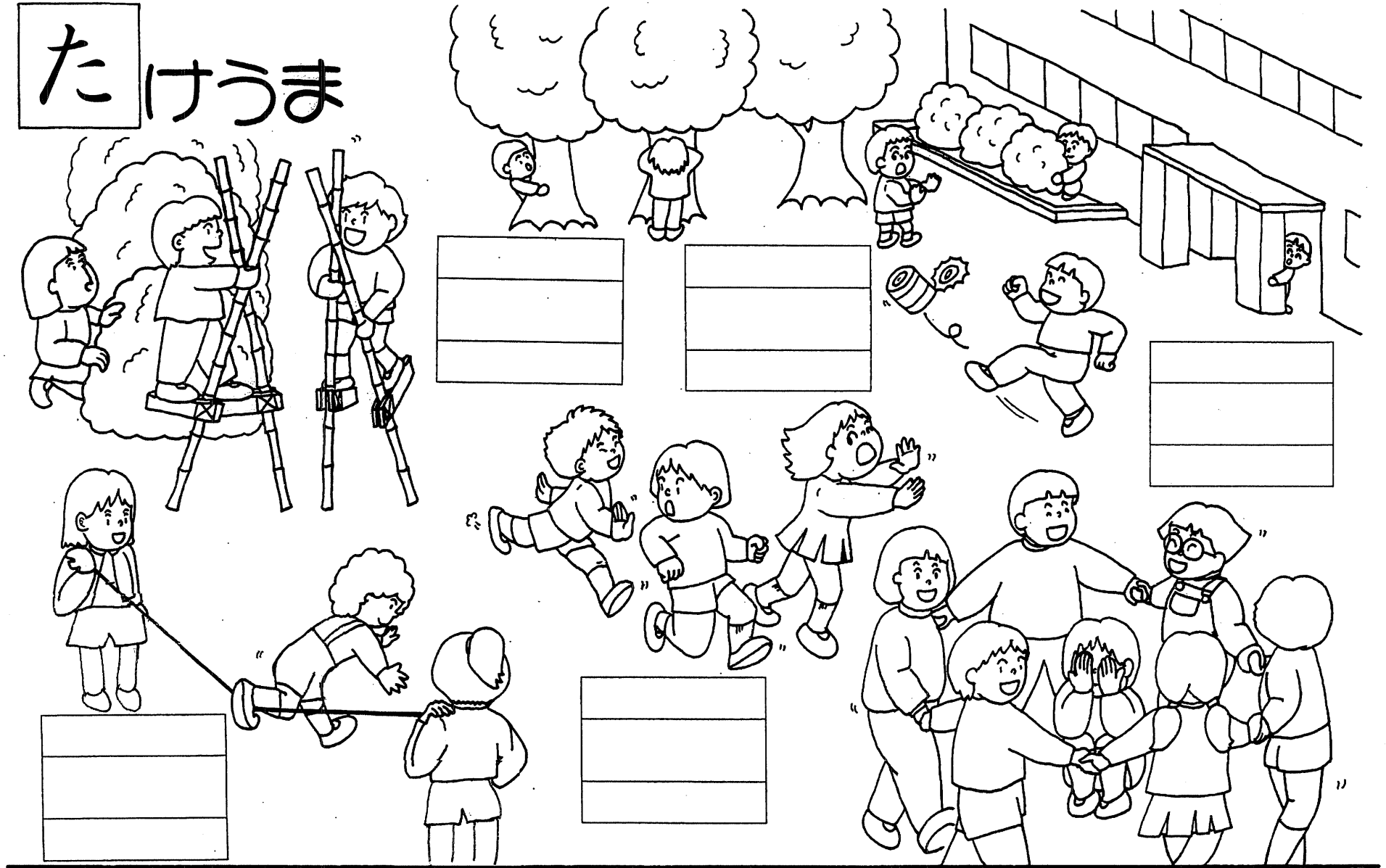
# たけうま



かくれんぼ      かんけり  
 ごむとび (びんとび)      おにごっこ      かごめかごめ

—— を      します      しました。

た

た (with stroke order numbers 1-4)

だ た

タ ta

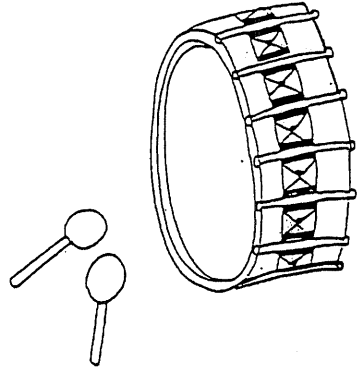

Blank writing box with three horizontal lines.

[た - - -]



Blank writing box with three horizontal lines.

[だ - - -]

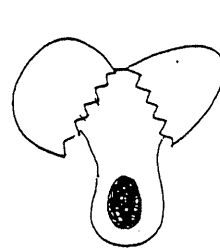

Blank writing box with three horizontal lines.

[た - - -]

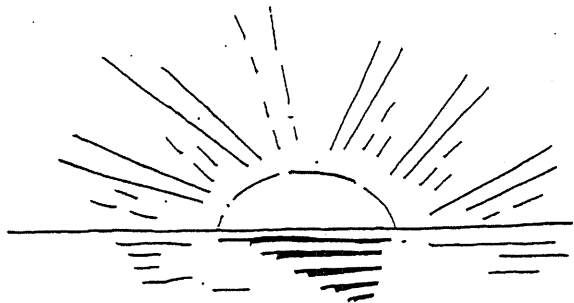

Blank writing box with three horizontal lines.

[た - - -]

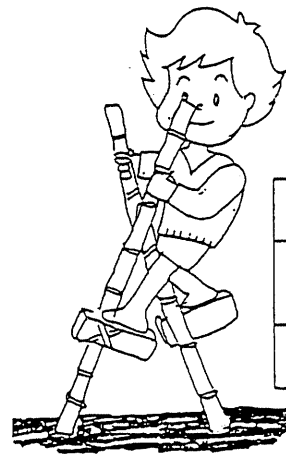

Blank writing box with three horizontal lines.

[た - - -]

ダ da

たいこ

たまご

だんす (ダンス)

たいよう

たけうま

# ちず

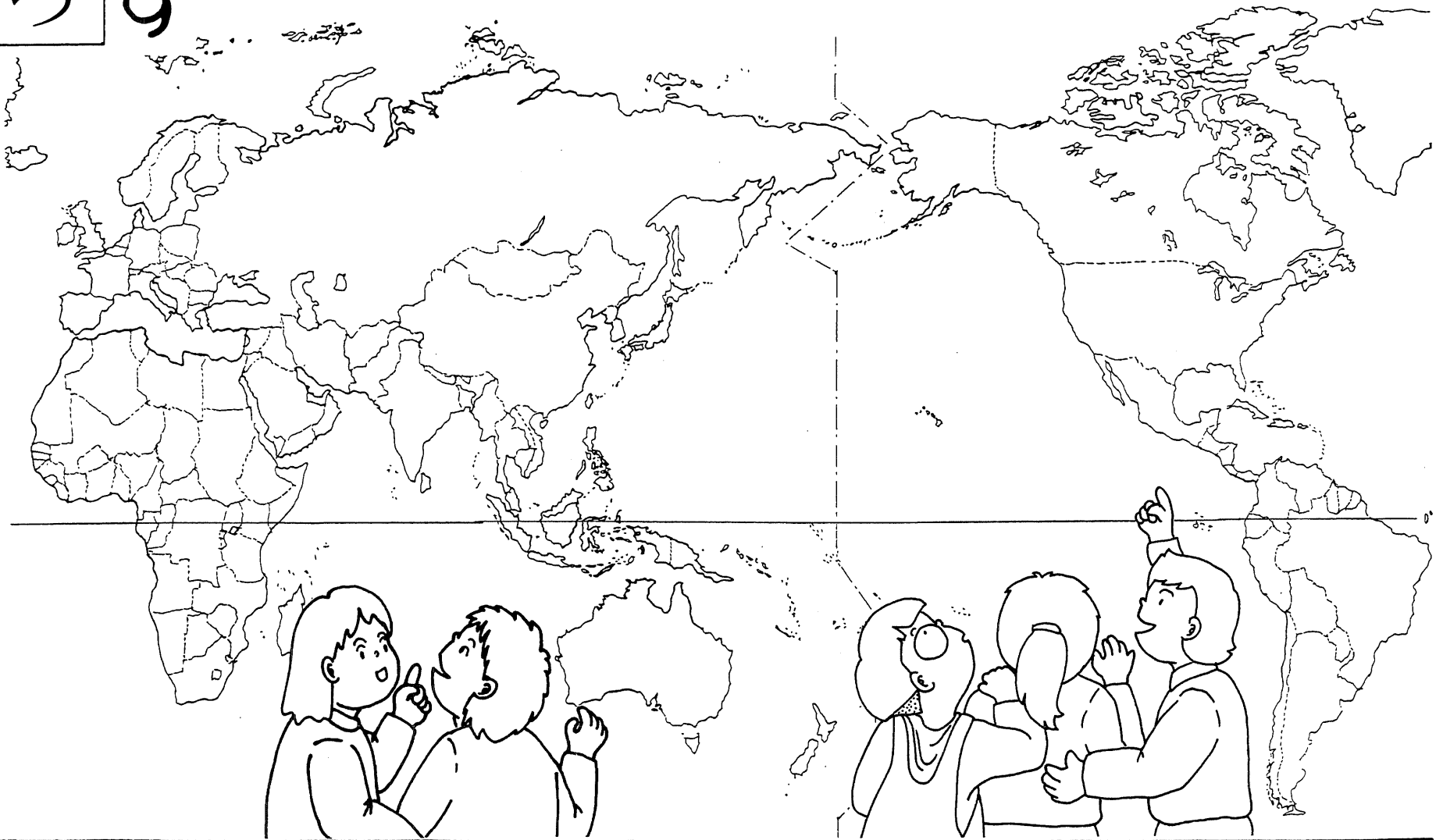

ちゅうごく にほん ぶらじる (ブラジル)  
べとなむ (ベトナム) ふいりぴん (フィリピン)

どこから きましたか？  
— から きました。

ち

① ②  
ち

ち ち

チ ti

ちや (チヤ)	tya
ちゆ (チユ)	tyu
ちよ (チヨ)	tyo
ぢや (ヂヤ)	(zya)
ぢゆ (ヂユ)	(zyu)
ぢよ (ヂヨ)	(zyo)

ヂ (zi)



Three horizontal lines for writing practice.

[ち]

Three horizontal lines for writing practice.

[ちや ...]

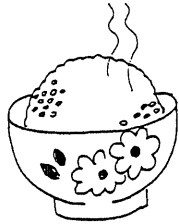

Three horizontal lines for writing practice.

[ちゅ ...]

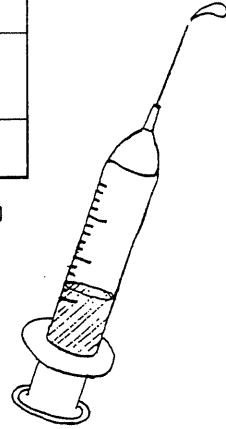

Three horizontal lines for writing practice.

[ち ...]

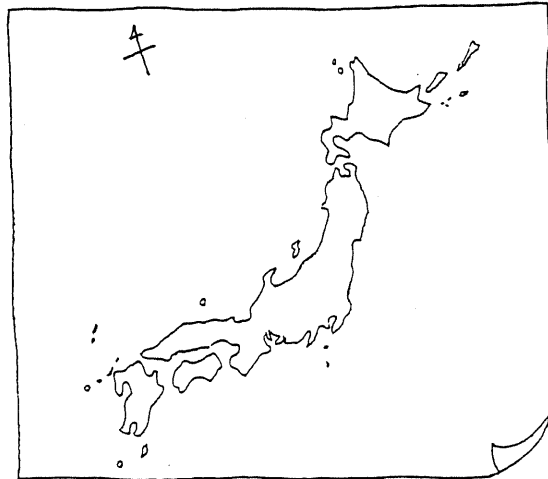

Three horizontal lines for writing practice.

[ち -]

ち

ちやわん

ちゅうしゃ

ちきゅう

ちず



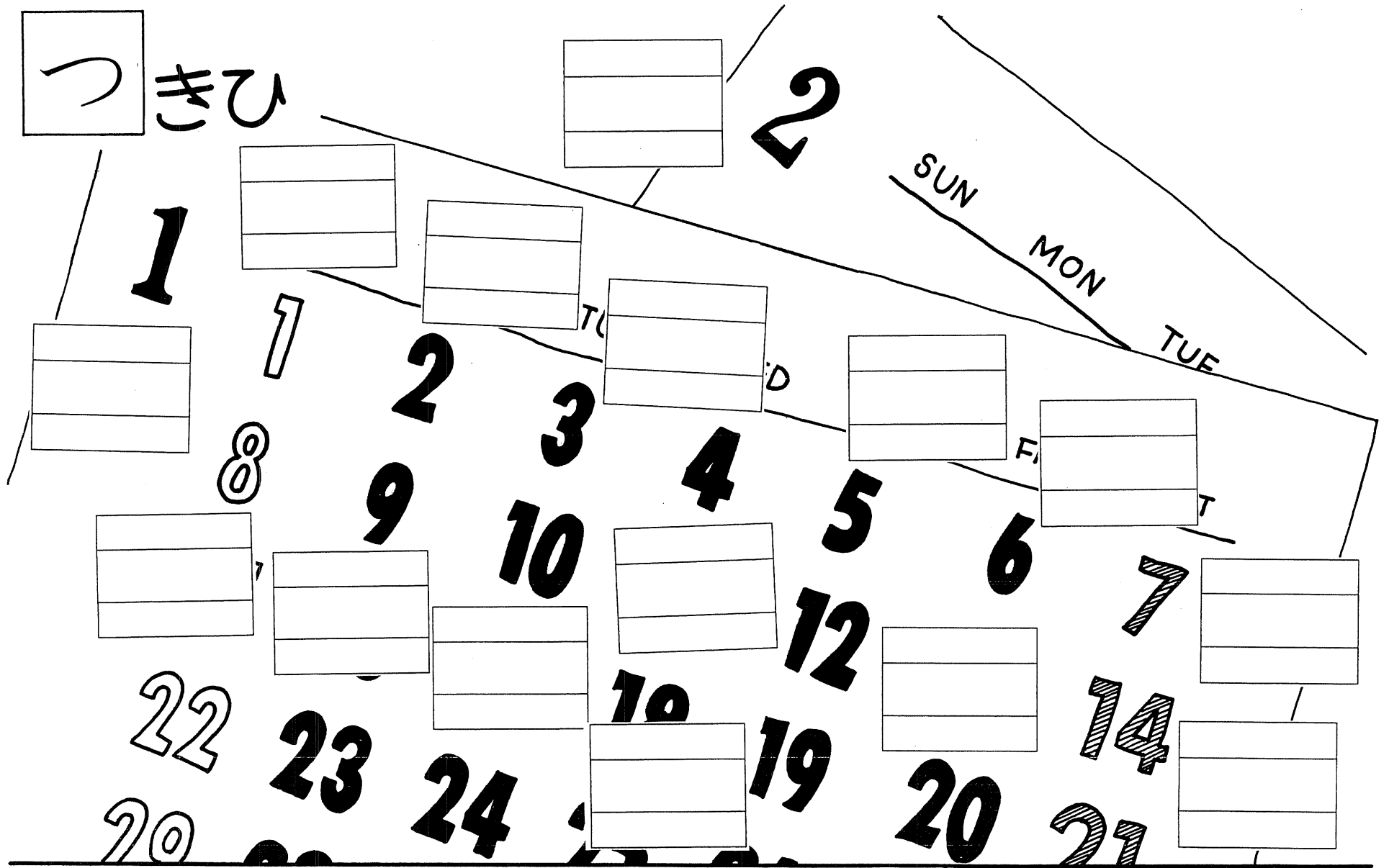

いちがつ (1月) にがつ (2月)

ついたち(1日) ふつか(2日) みっか(3日) よっか(4日) いつか(5日) むいか(6日) なの(7日) が(7日)  
 ようか(8日) ここのか(9日) とおか(10日) じゅうよっか(14日)  
 じゅうくにち(19日) はつか(20日)

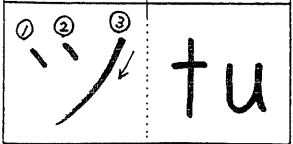
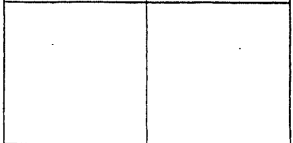
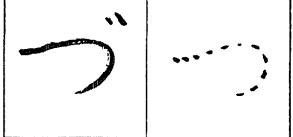
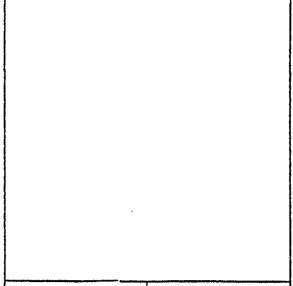
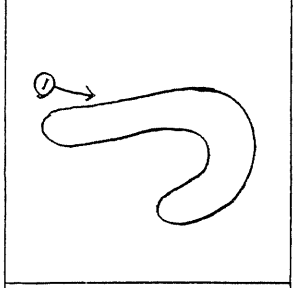
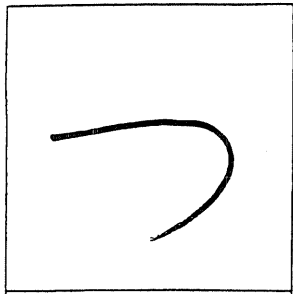

1 JANUARY						
Sun	Mon	Tue	Wed	Thu	Fri	Sat
						1 元日・休日
2 FEBRUARY	3 Wed	4 Thu	5 Fri	6 Sat	7 日曜日	8 月曜日
9 Tue	10 Wed	11 Thu	12 Fri	13 Sat	14 日曜日	15 月曜日
16 Tue	17 Wed	18 Thu	19 Fri	20 Sat	21 日曜日	22 月曜日
23 Tue	24 Wed	25 Thu	26 Fri	27 Sat	28 日曜日	29 月曜日

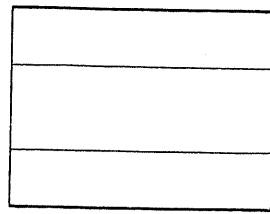

[つ...]

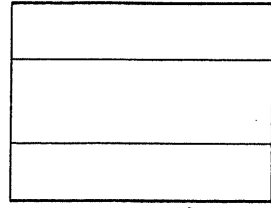
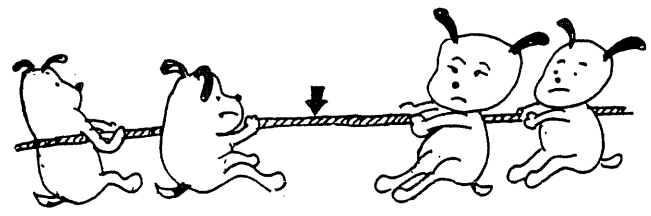

[つ...]

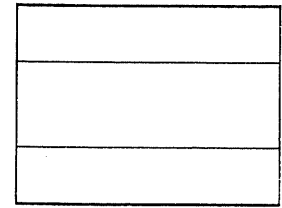
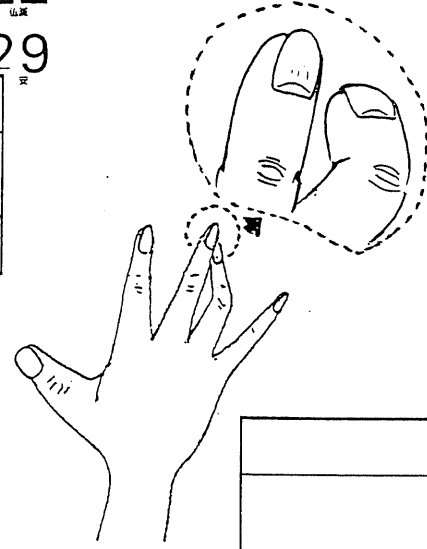

[つ...]

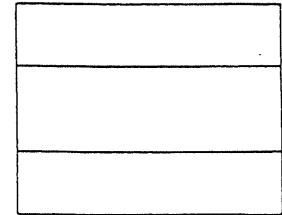
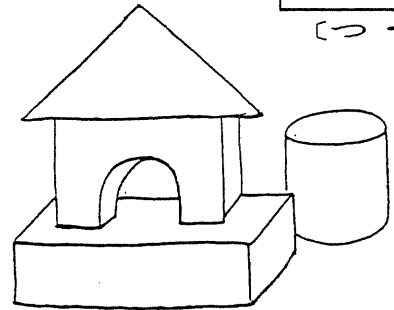
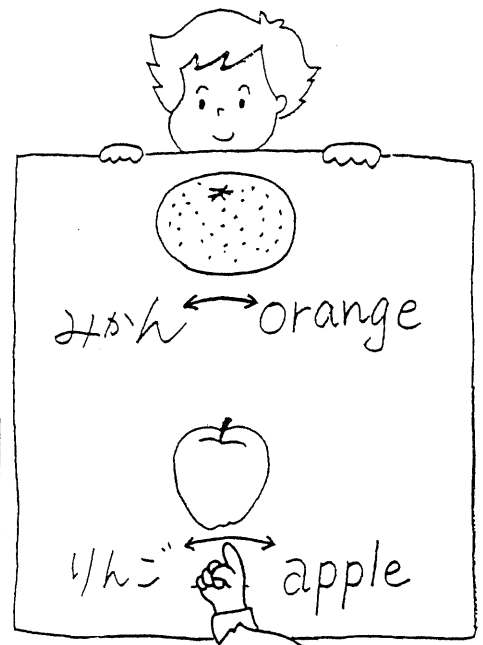

[つ...]

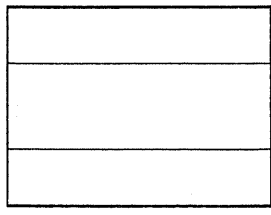

[つ...]

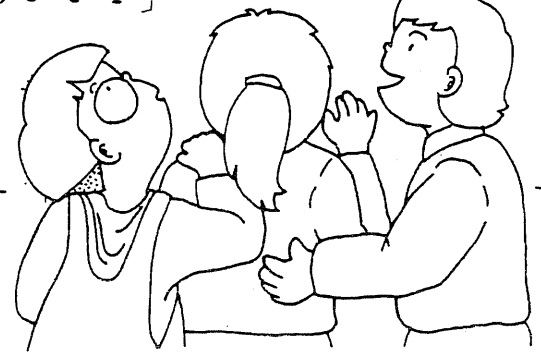

ツ (zu)

- つきひ
- つみき
- つな
- つめ
- つうやく

て

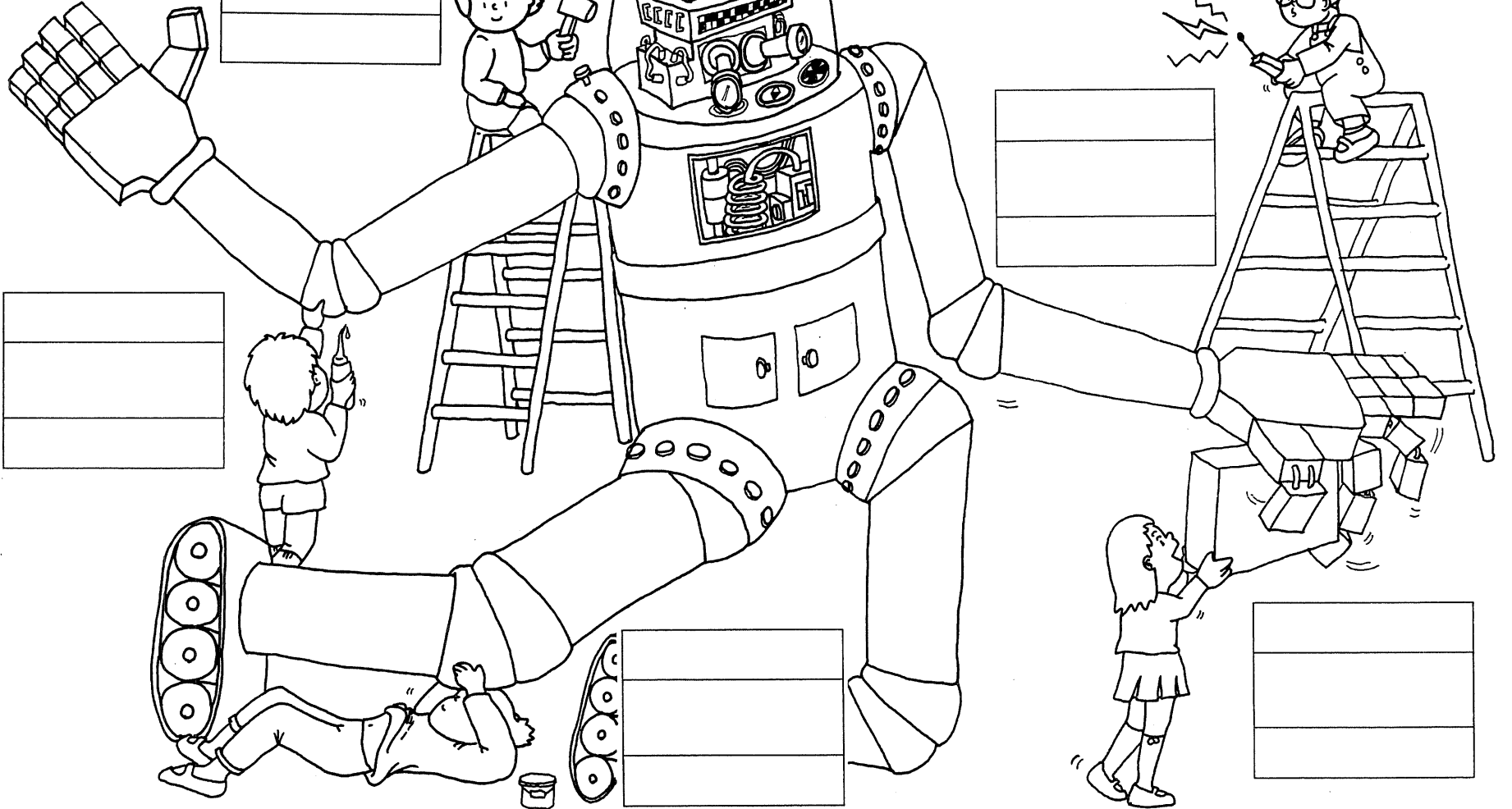

ひじ

かた  
ひざ

うで  
ゆび

まげて		
のぼして	を	ください。
まわして		

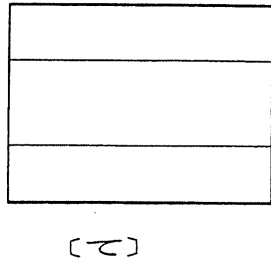
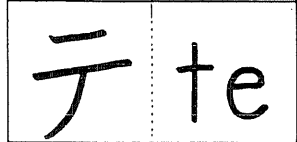
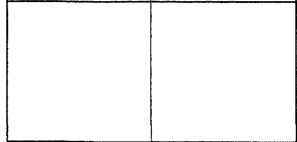
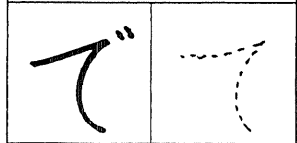
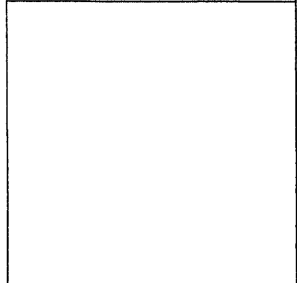
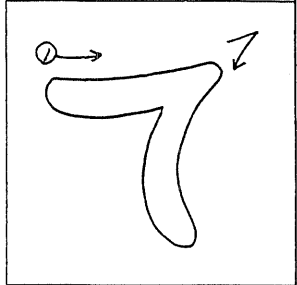
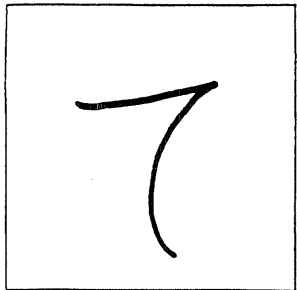

[て]

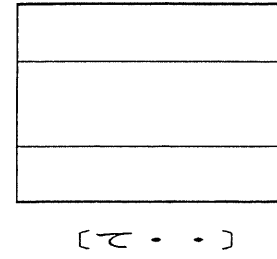
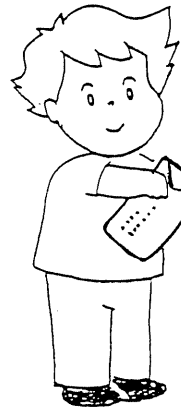

[て...]

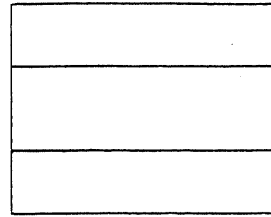

[て...]

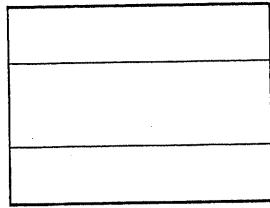
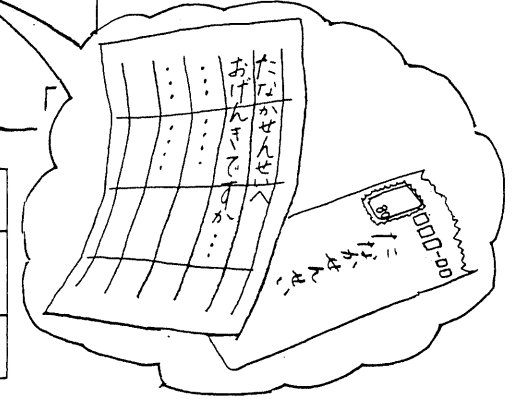

[て...]

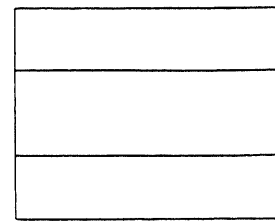
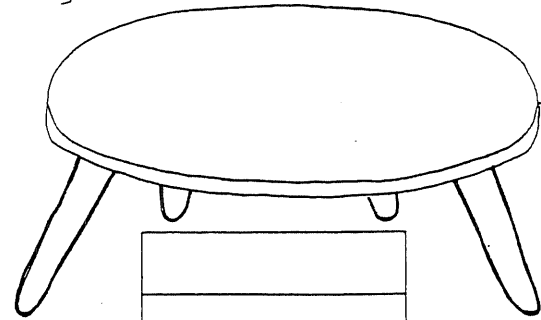
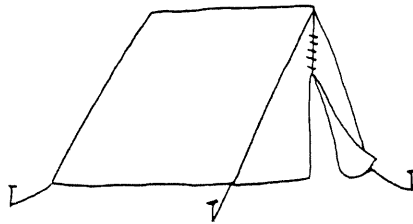
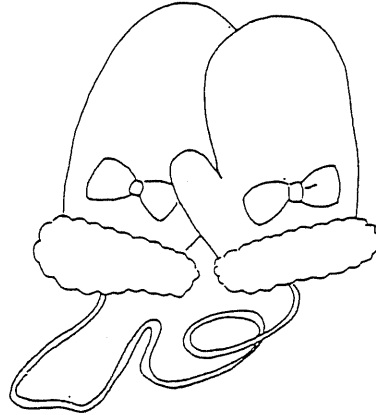

[て...]

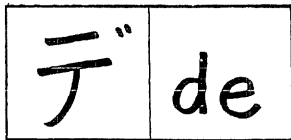

て

てんと (テント)

てぶくろ

てがみ

てぶる (テーブル)

とけい

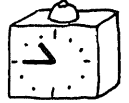
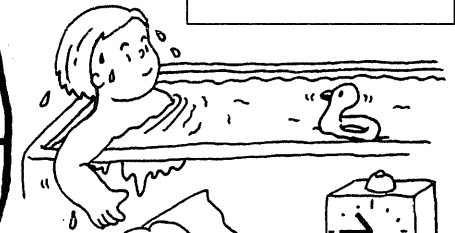
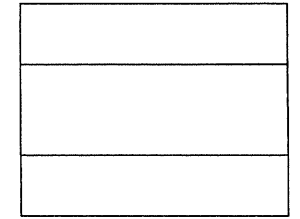
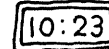
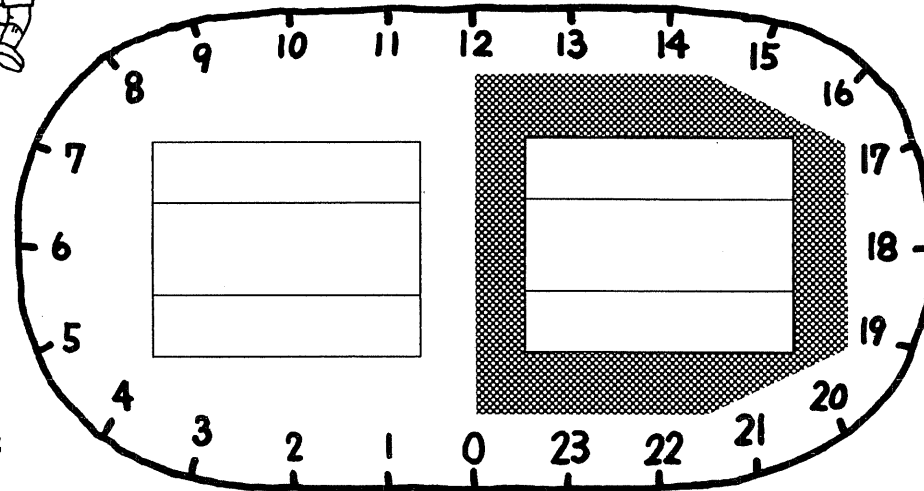
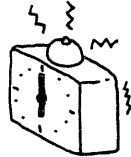
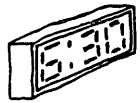
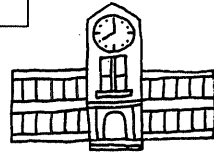
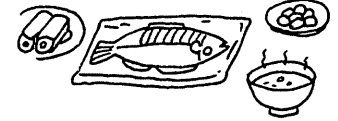
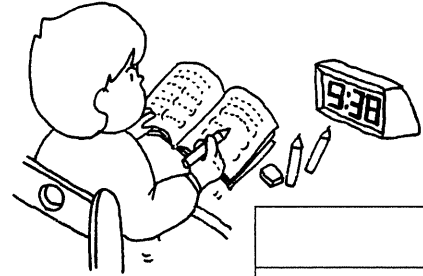
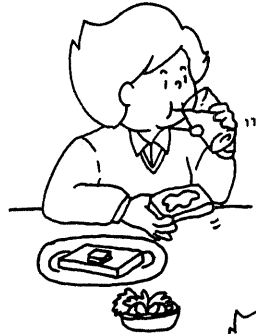
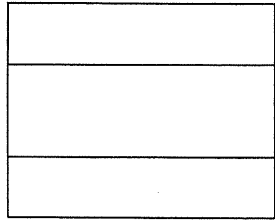
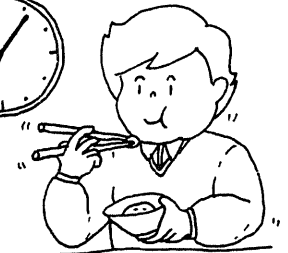
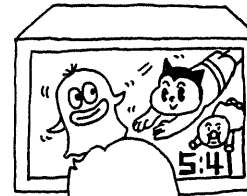
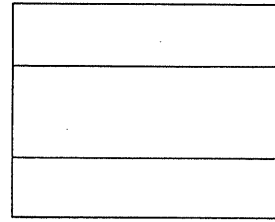
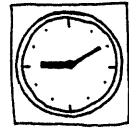

あさ ひる よる  
ごぜん ごご

と

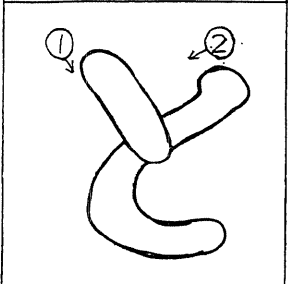

と" と

ト to

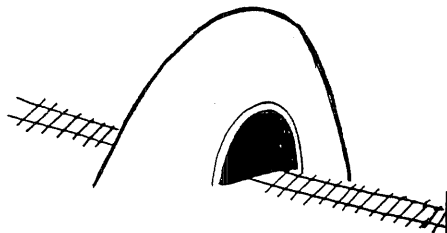

Blank writing box with three horizontal lines.

[と . . .]

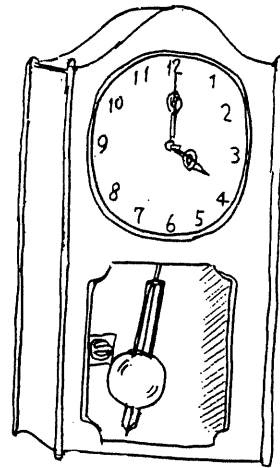

Blank writing box with three horizontal lines.

[と . . .]

[と . . .]

Blank writing box with three horizontal lines.

[と . .]

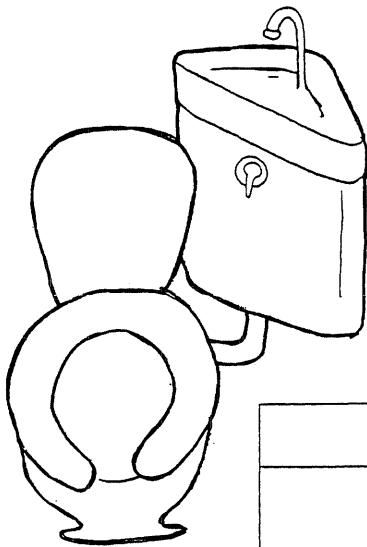

Blank writing box with three horizontal lines.

Blank writing box with three horizontal lines.

[と . . .]

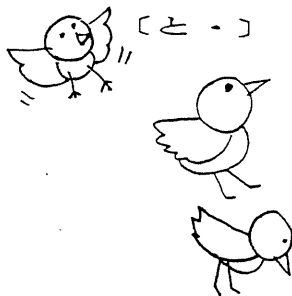

[と . .]

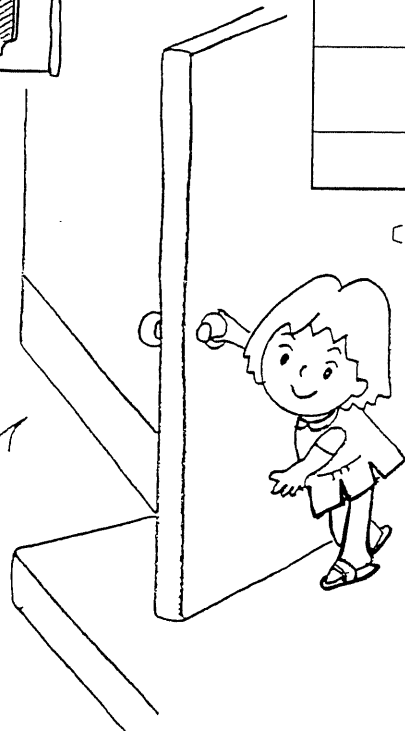

ト" do

とんねる (トンネル)

とけい

といれ (トイレ)

とり

どあ (ドア)

なつ

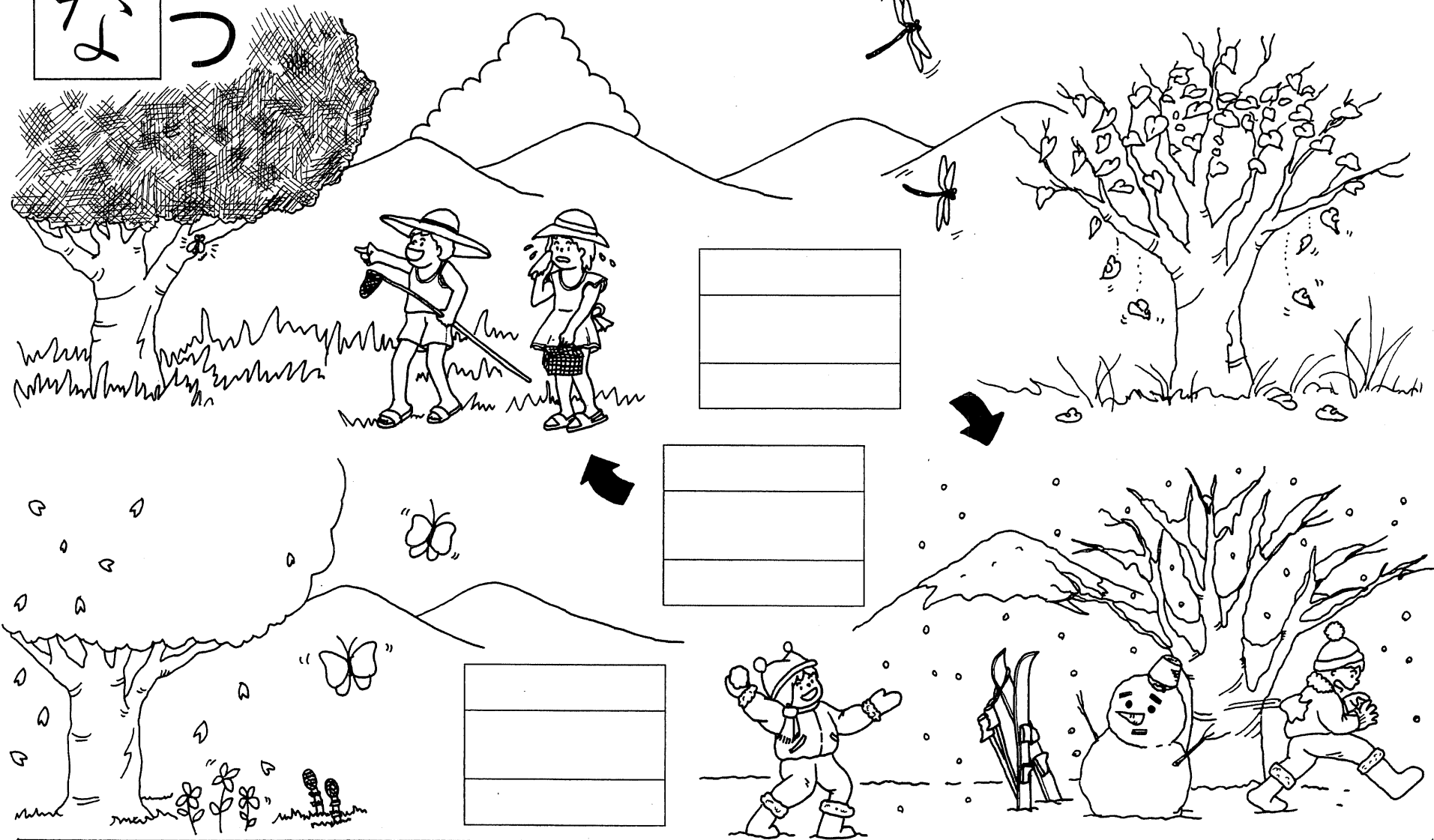

はる

あき  
ふゆ

— は — より

あつ むい あ す	た た か い ず し い	です。
--------------------	---------------------------------	-----

な

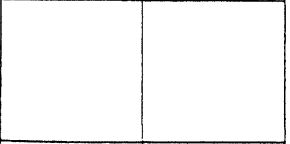
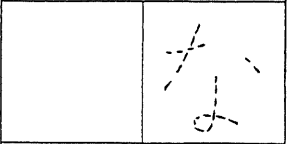
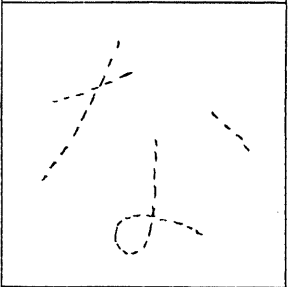
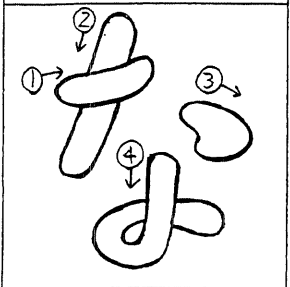

na

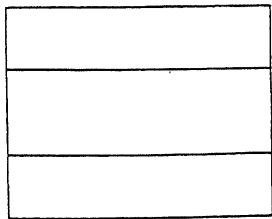
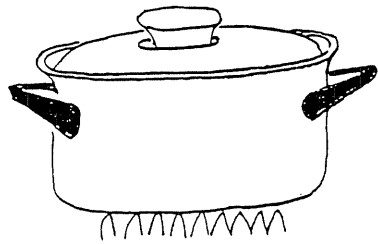

[な - ]

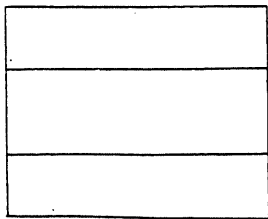
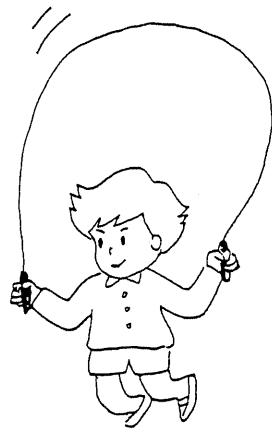

[な - - - ]

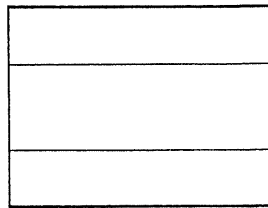
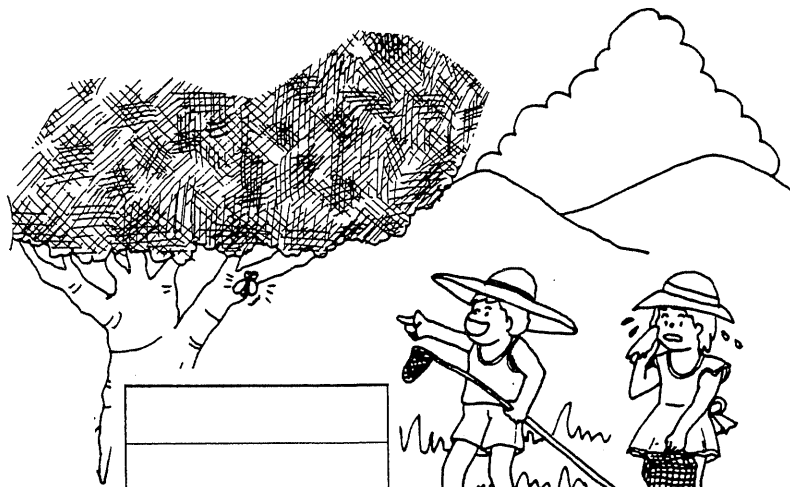

[な - ]

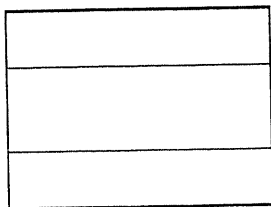

[な - - ]

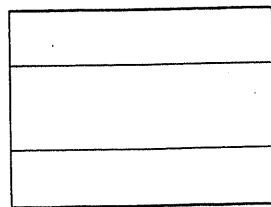

[な - ]



なべ

なわとび

なつ

なみだ

なみ



# に ちょうび



		<b>5</b>				
SUN 日	MON 月	TUE 火	WED 水	THU 木	FRI 金	SAT 土
<b>1</b>	<b>2</b>	<b>3</b>	<b>4</b>	<b>5</b>	<b>6</b>	<b>7</b>
<b>8</b>	<b>9</b>			<b>12</b>		

げつようび かようび すいようび もくようび きんようび どようび

に

① ↓ ② →

③ ↻

に

二 ni

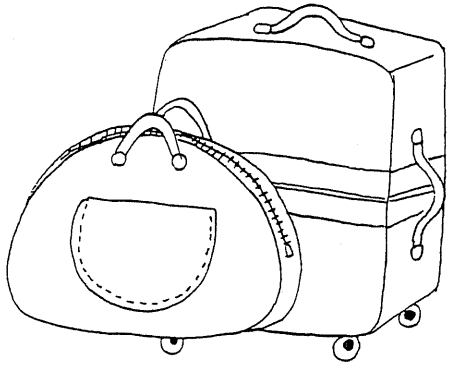

[ に - - - ]

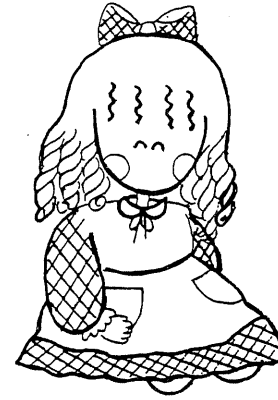

[ に - - ]

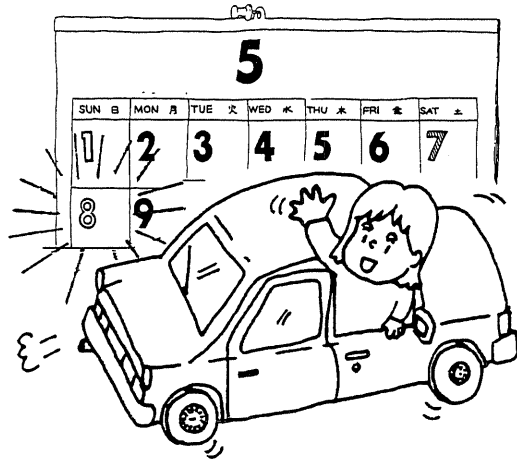

[ に - - - ]

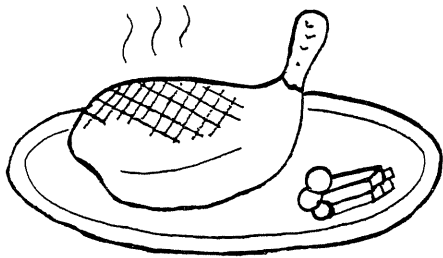

[ に - ]

[ に - - - ]

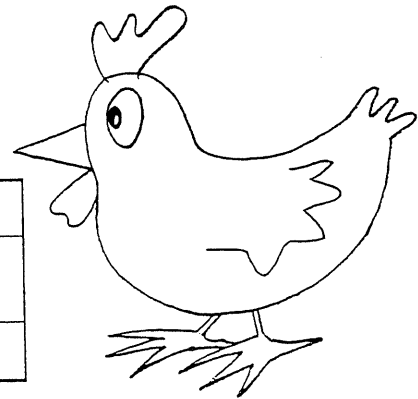

にもつ

にんぎょう

にちようび

にく

にわとり

ぬりえ

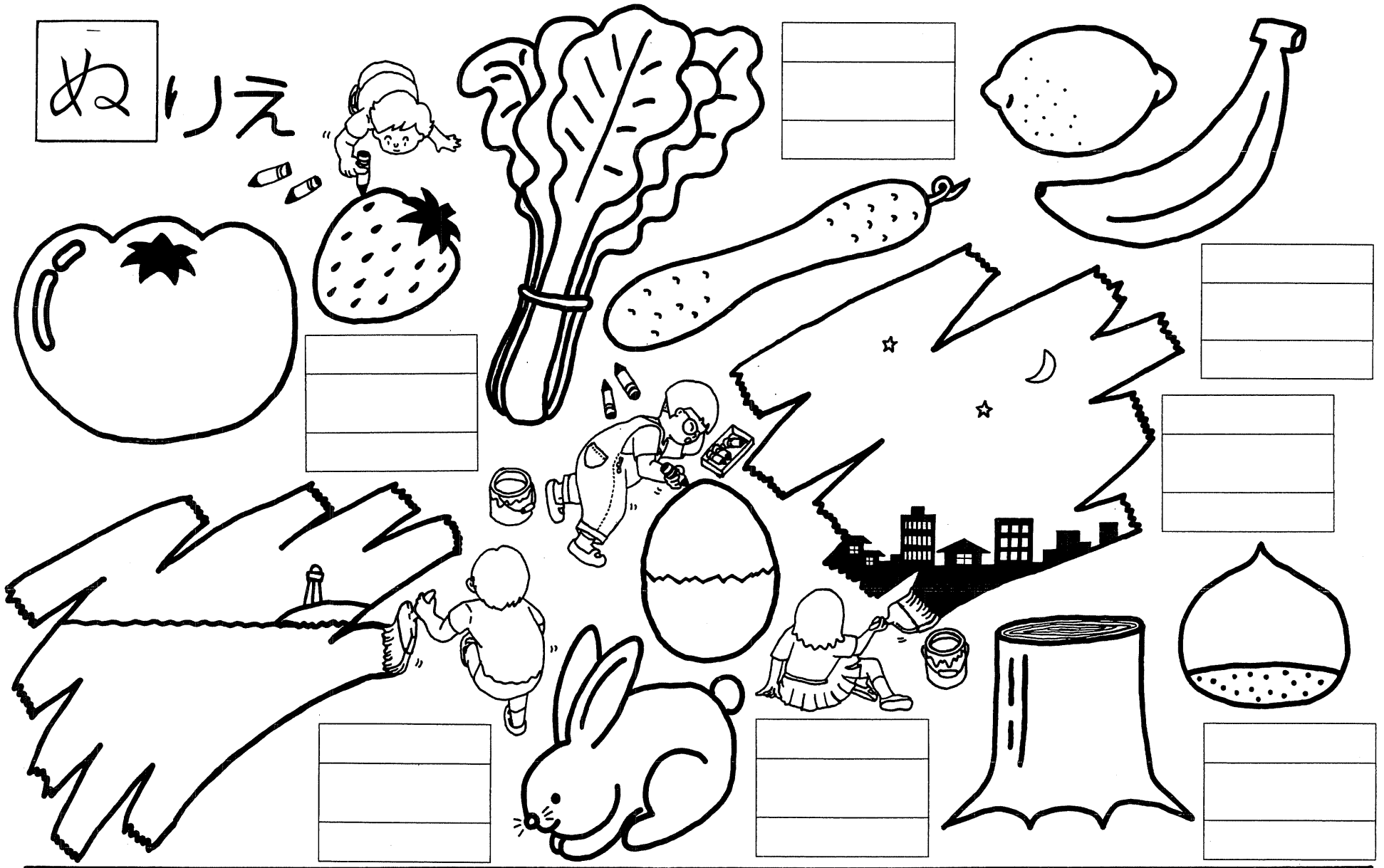

あか

みどり

きいろ

くろ

あお

しろ

ちゃいろ

あか	あお	きいろ	みどり
しろ	くろ	ちゃいろ	びんく
			むらさき

ぬ

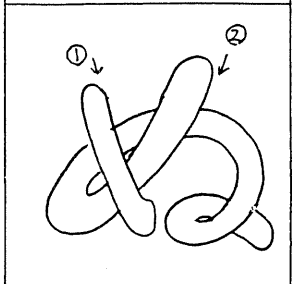

[ぬ - - - -]

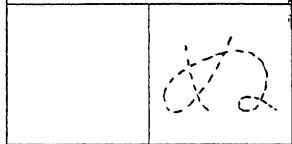

[ぬ - - - -]

又 nu

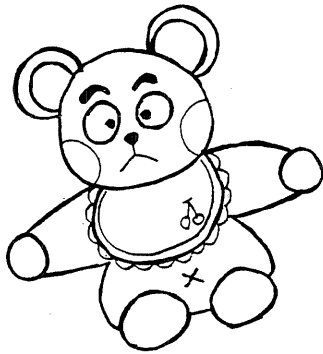

[ぬ - - - -]



[ぬ - - - -]

[ぬ - - -]

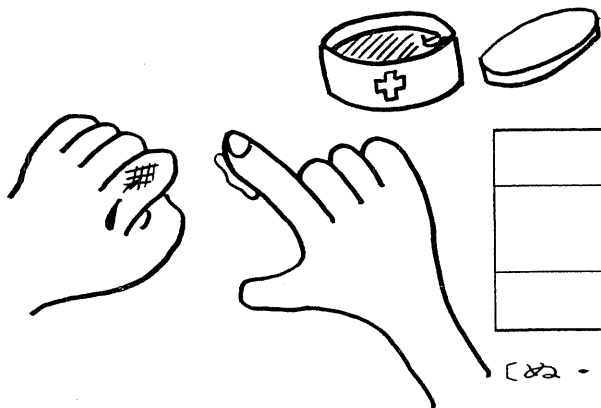
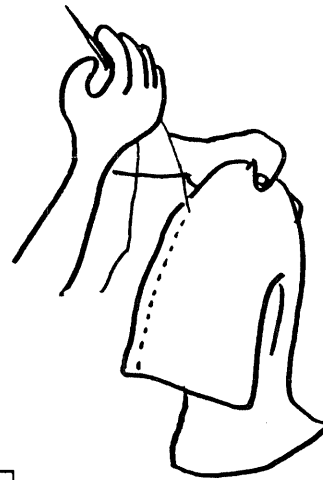

[ぬ - - - -]

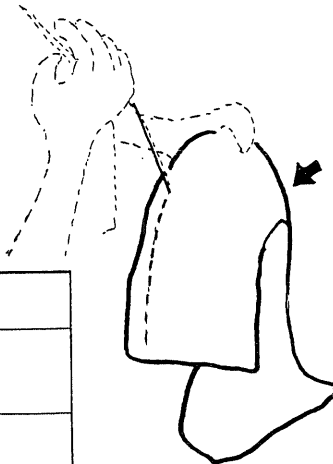

[ぬ - -]

ぬいぐるみ

ぬいもの

ぬりえ

ぬりぐすり

ぬの

ねだん



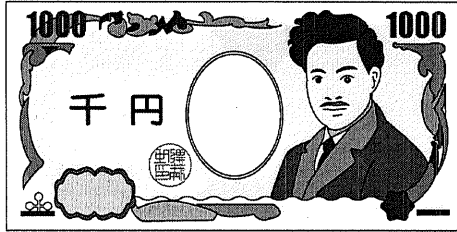
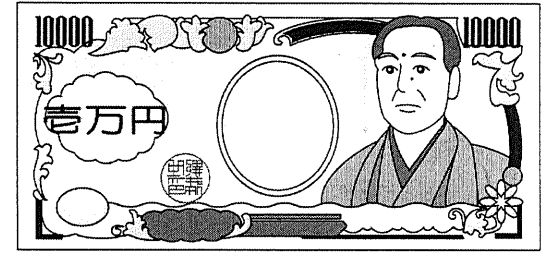

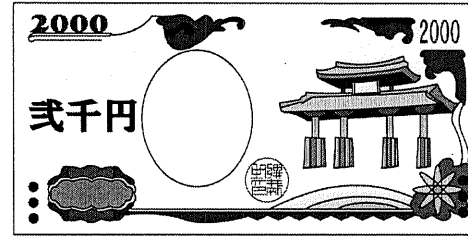







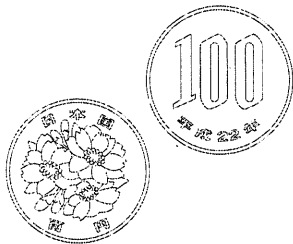

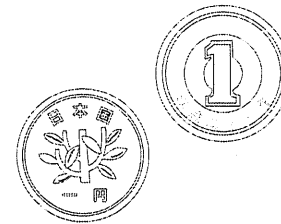
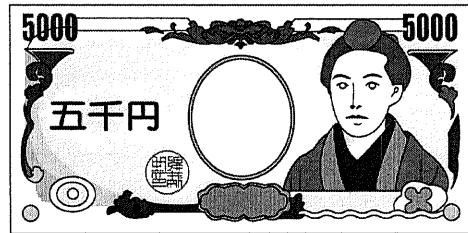
- |             |             |             |               |
|-------------|-------------|-------------|---------------|
| せんえん(1000)  | ごじゅうえん(50)  | にせんえん(2000) | いちまんえん(10000) |
| ごひゃくえん(500) | じゅうえん(10)   | ごえん(5)      |               |
| ひゃくえん(100)  | ごせんえん(5000) | いちえん(1)     |               |

これはいくらですか？  
 (これは) \_\_\_\_\_ です。

ね

ね (with stroke order arrows 1 and 2)

Blank handwriting practice box

ね (dashed for tracing)

Blank handwriting practice box

ネ ne

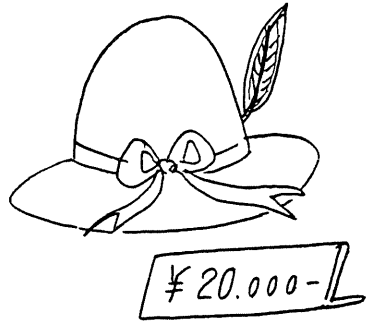

Blank handwriting practice box

[ね - -]

Blank handwriting practice box

[ね -]

Blank handwriting practice box

[ね -]



Blank handwriting practice box

[ね - - -]

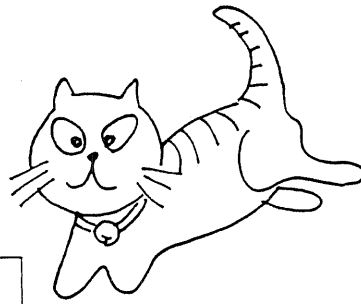

Blank handwriting practice box

[ね -]

Blank handwriting practice box

[ね]

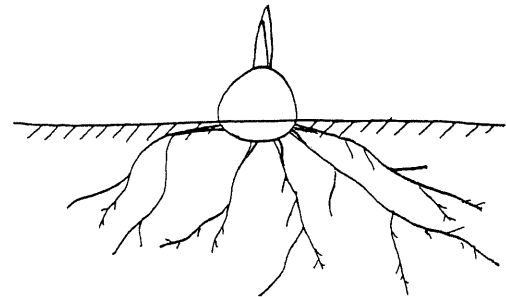
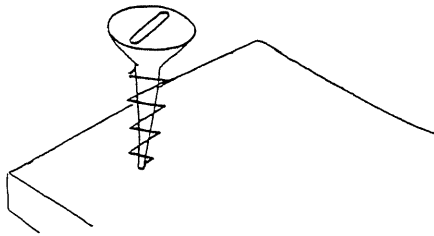
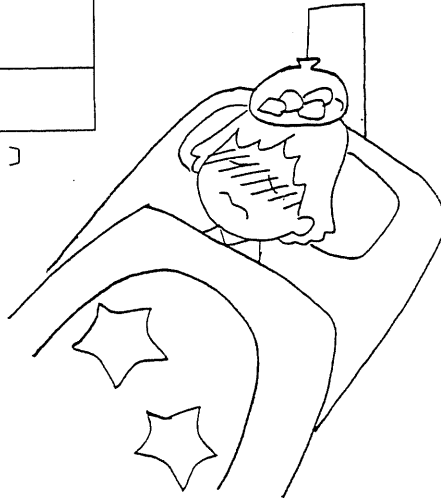

ねだん

ねじ

ねくたい (ネクタイ)

ねつ

ねこ

ね

# のりもの

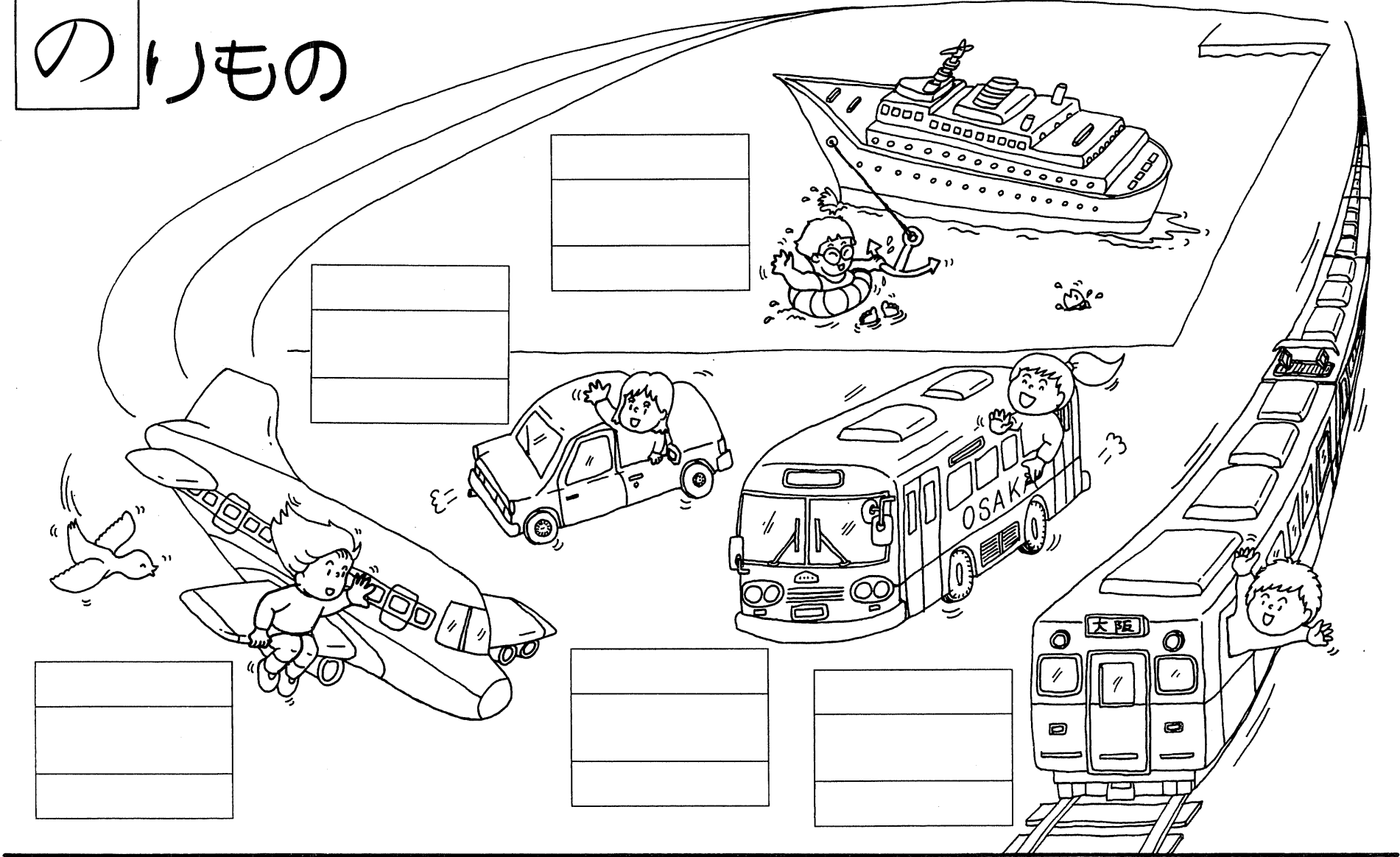

ひこうき    くるま    ぶね  
 ばす(バス)    でんしゃ

はしって  
 — が    とんで    います。  
 すすんで

/	no

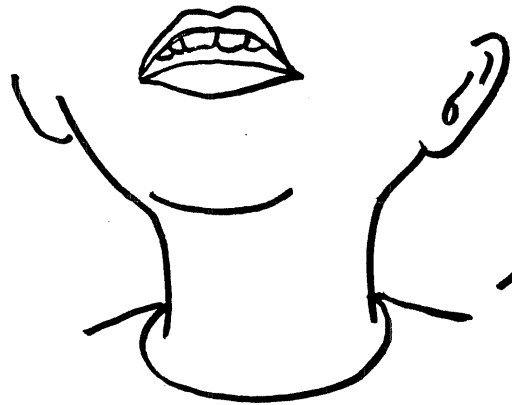

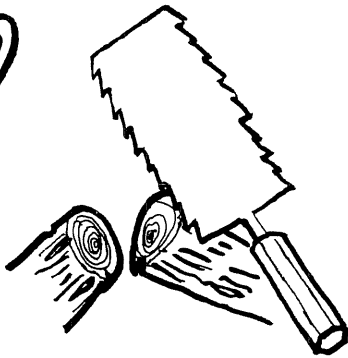

[ の - ]



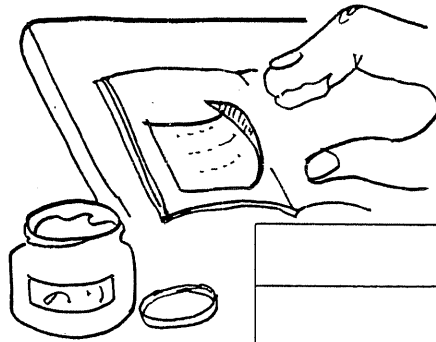

[ の . . . ]

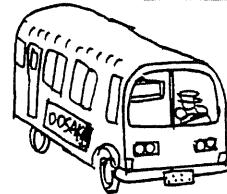
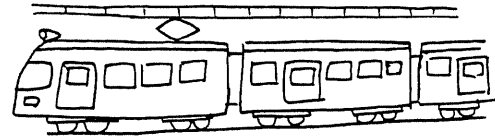



[ の - ]

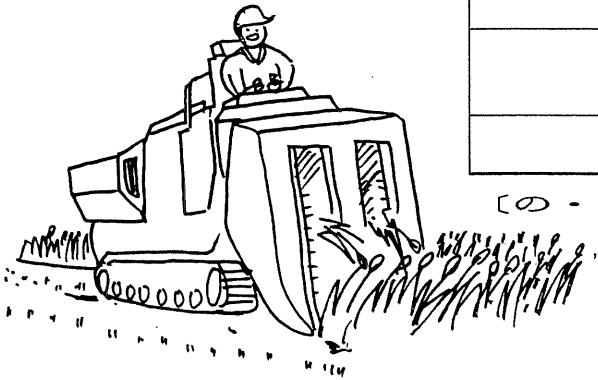

[ の . . . ]

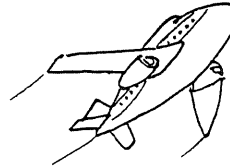

[ の . . . ]



のど

のこぎり

のり

のうぎょう

のりもの



はれ

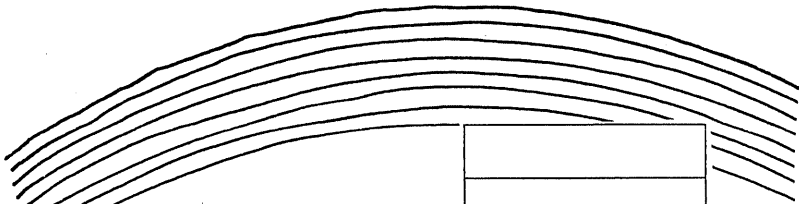
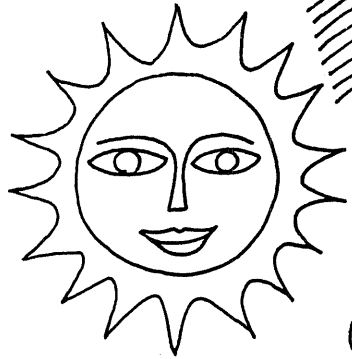

Blank box with three horizontal lines for labeling.



Blank box with three horizontal lines for labeling.



Blank box with three horizontal lines for labeling.



Blank box with three horizontal lines for labeling.

Blank box with three horizontal lines for labeling.

Blank box with three horizontal lines for labeling.

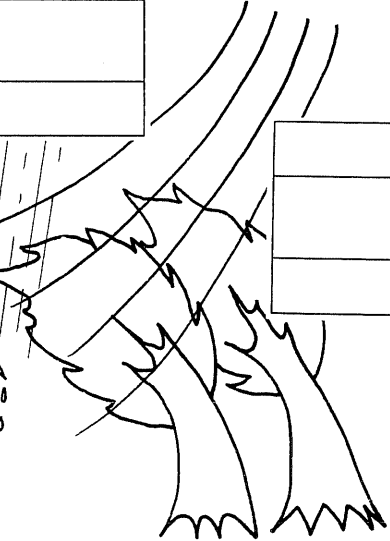

にじ かみなり

くもり ゆき あめ かぜ

は

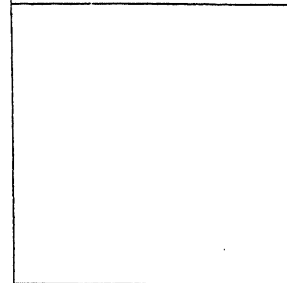
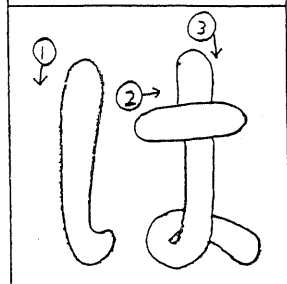

は

は

ハ ha

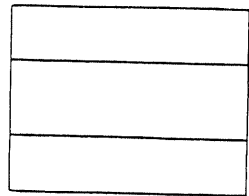

[は - -]

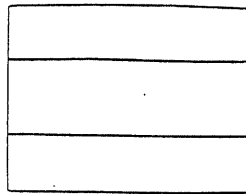
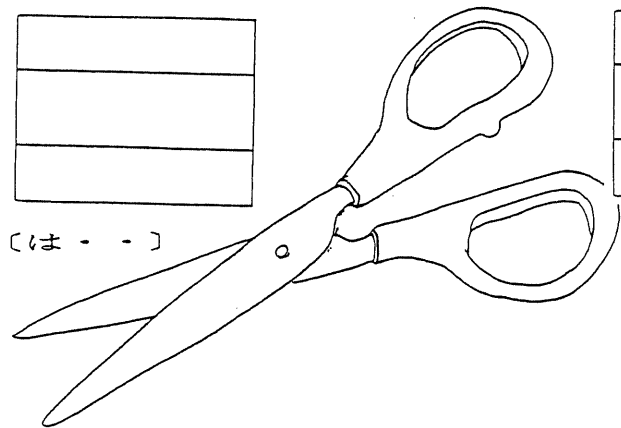

[は -]

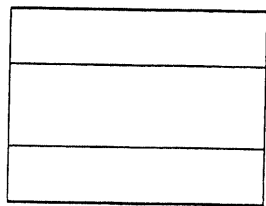
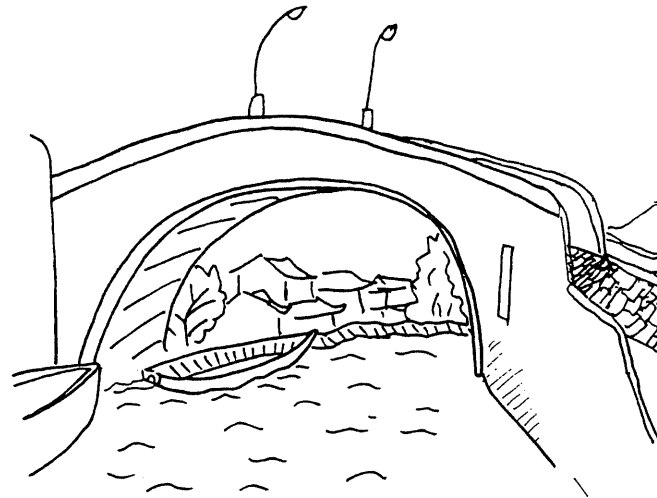

[は -]

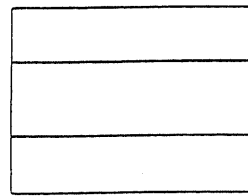
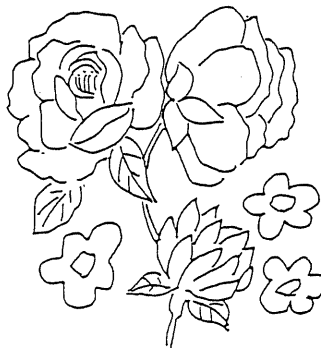

[は -]

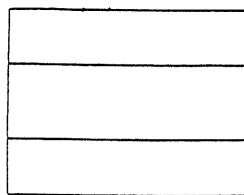
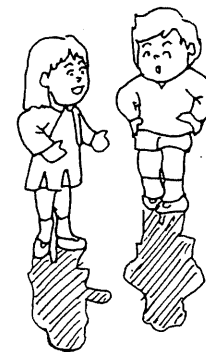
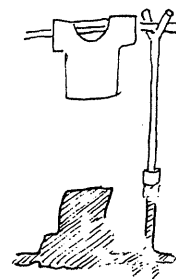

[は -]

バ ba

パ pa

はさみ

はし

はな

はた

はれ

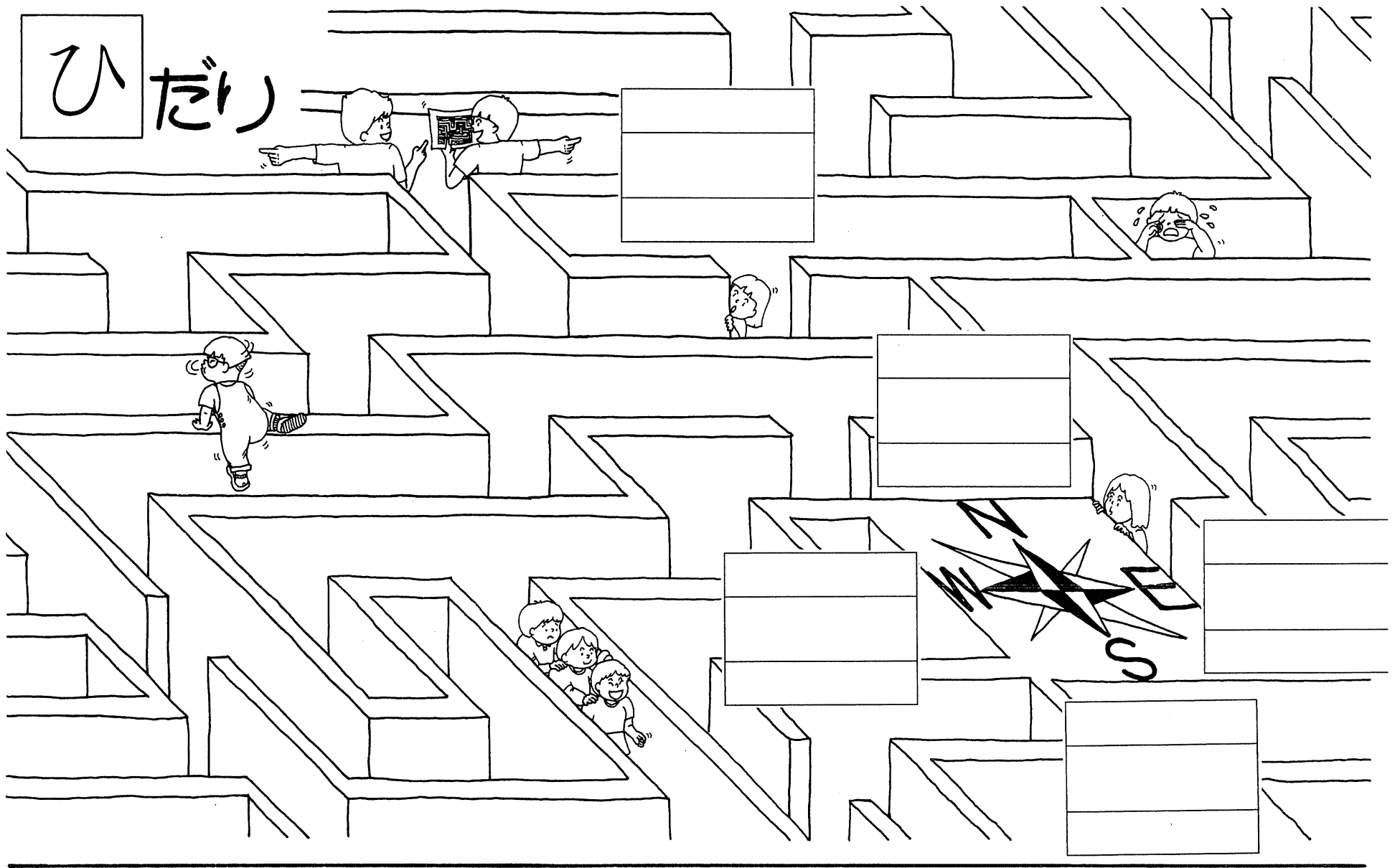

みぎ

きた

にし ひがし

みなみ

ひ

ひ

び ひ

ぴ

hi

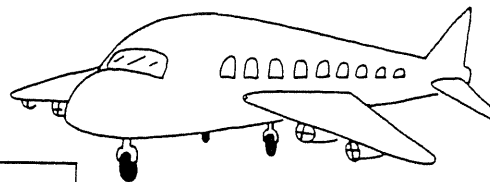
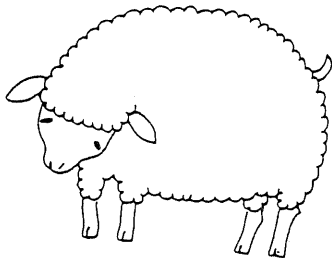

Blank handwriting practice box with three horizontal lines.

[ひ...]

Blank handwriting practice box with three horizontal lines.

[ひ...]

Blank handwriting practice box with three horizontal lines.

[ひ...]

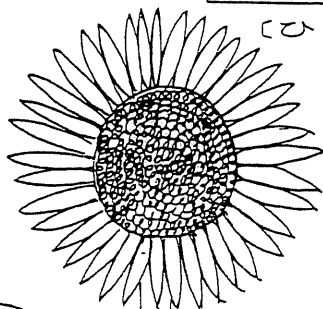

Blank handwriting practice box with three horizontal lines.

[ひ...]

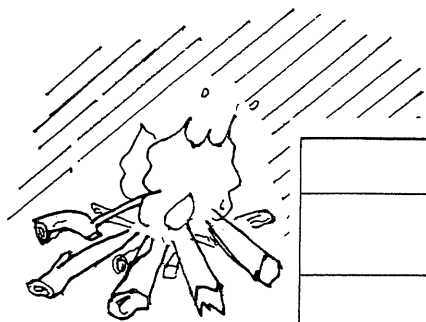

Blank handwriting practice box with three horizontal lines.

[ひ]



ひゃ (ヒヤ)	hya
ひゅ (ヒュ)	hyu
ひょ (ヒョ)	hyo
びゃ (ビヤ)	bya
びゅ (ビュ)	byu
びょ (ビョ)	byo
ぴゃ (ピヤ)	pya
ぴゅ (ピュ)	pyu
ぴょ (ピョ)	pyo

び bi

ぴ pi

ひだり  
ひ

ひつじ  
ひまわり

ひこうき

ふ

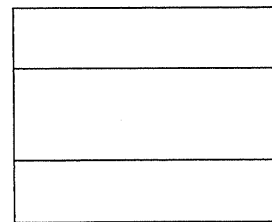
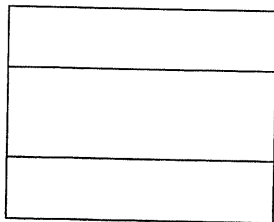
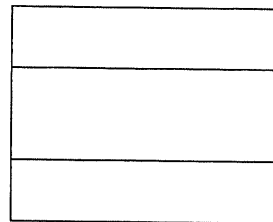
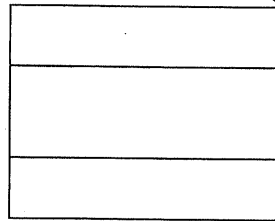
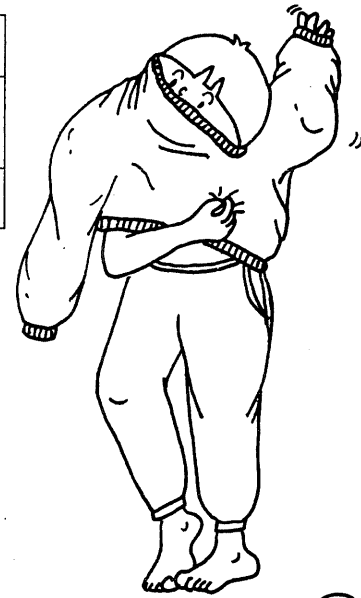
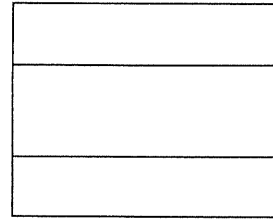
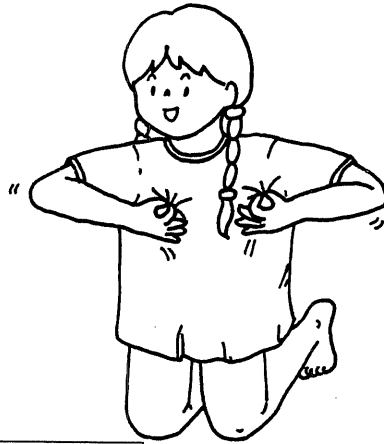
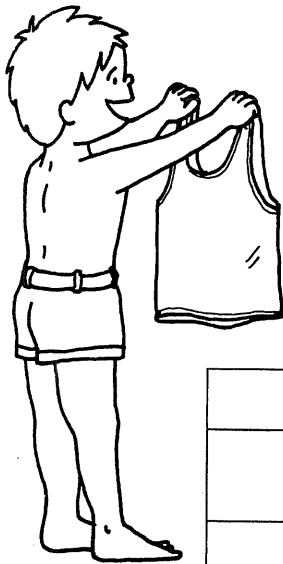
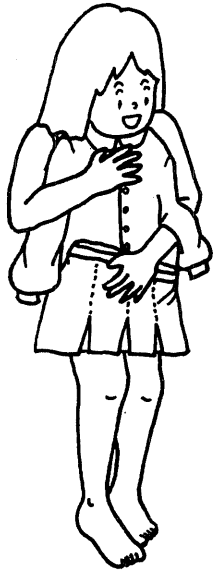

しゃつ (シャツ)      せーたー (セーター)  
 くつした      すかーと (スカート)      ずぼん (ズボン)

— を      着ます。      — を      着て      ください。  
 はきます。      ぬぎます。      はいて      ぬいで

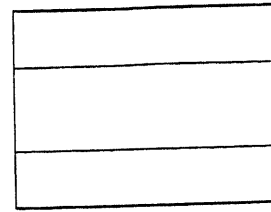
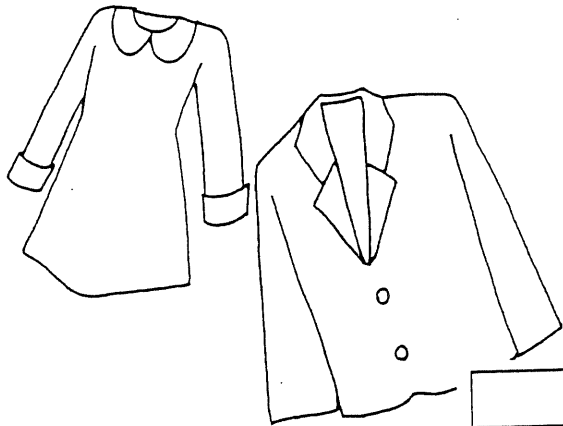
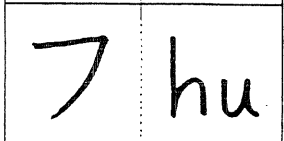
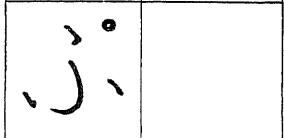
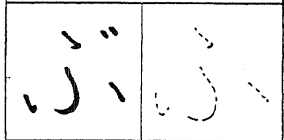
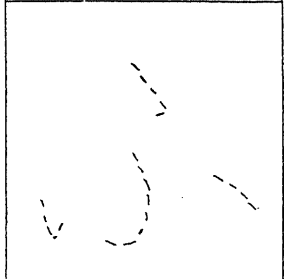
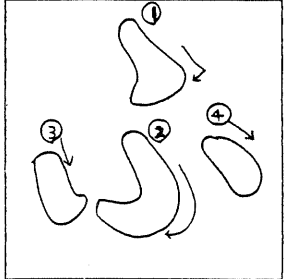
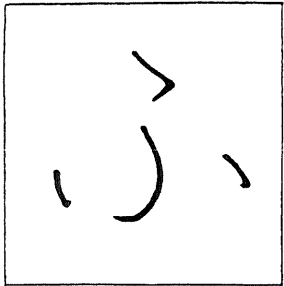

[ふ・]

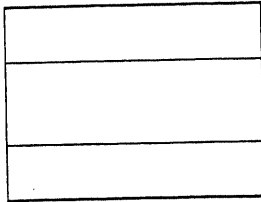

[ふ・]

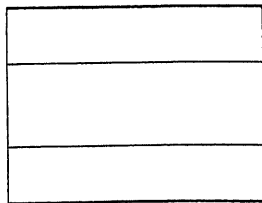
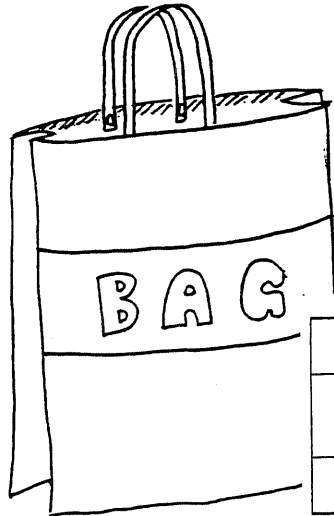
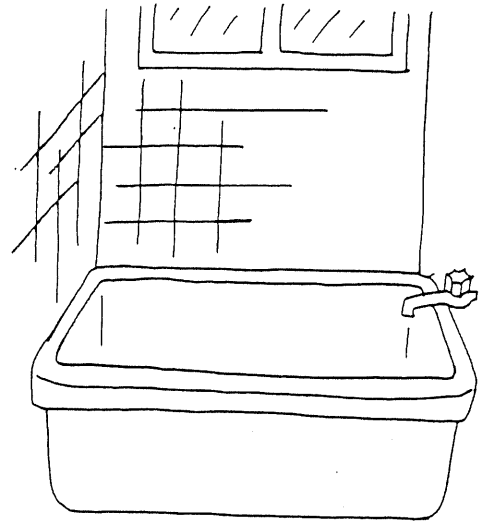

[ふ・・]

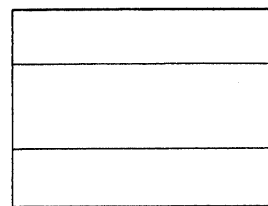
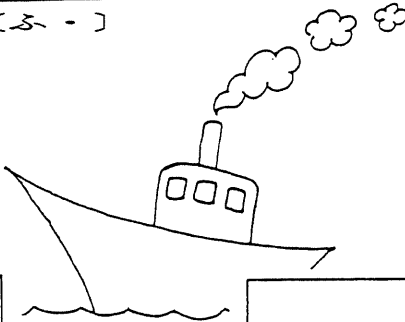

[ふ・]

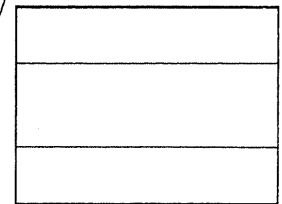
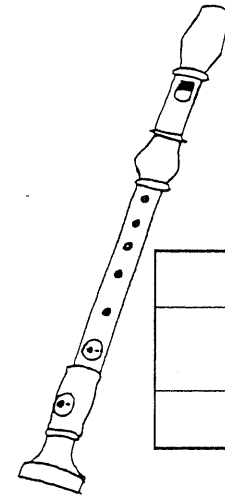

[ふ・]

フ bu

フ pu

ふく

ふくろ

ふね

ふろ

ふえ



# んきょう

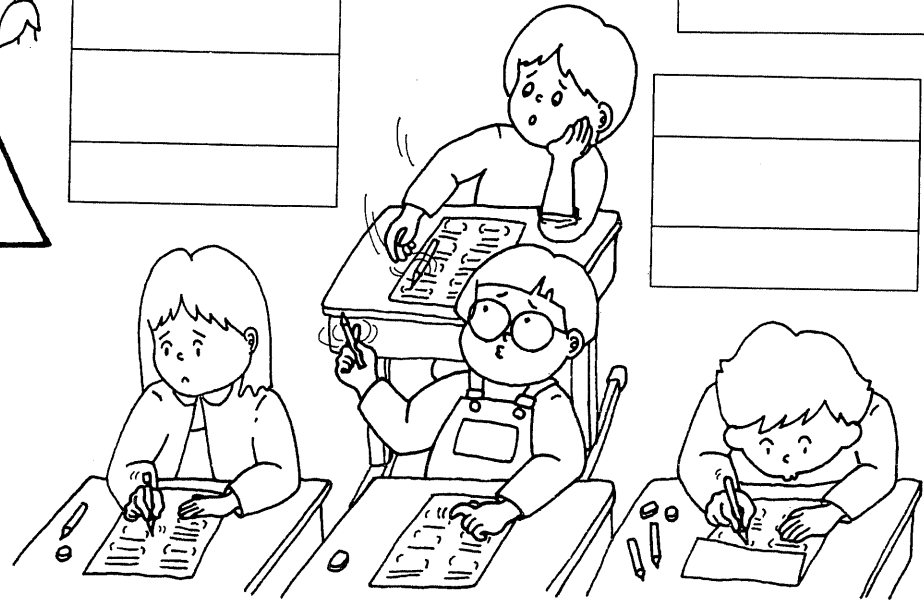
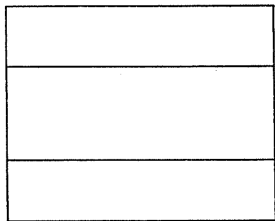
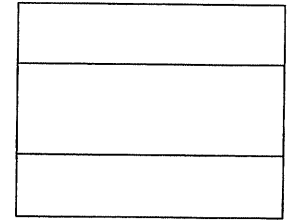
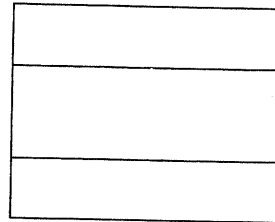
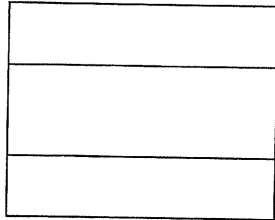
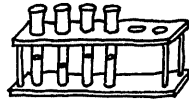
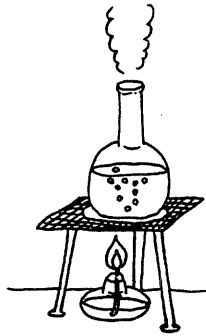

じっけん      かんさつ      はっぴょう  
しゅくだい      てすと (テスト)

——をしましょう。

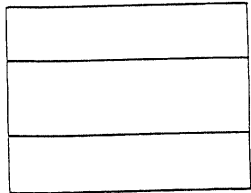
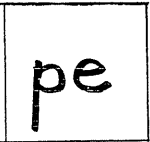
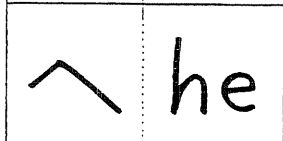
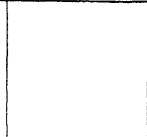
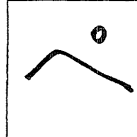
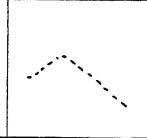
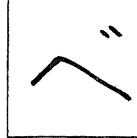
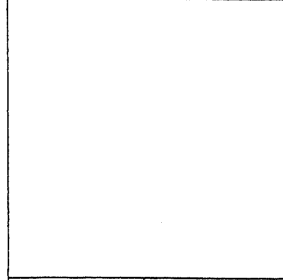
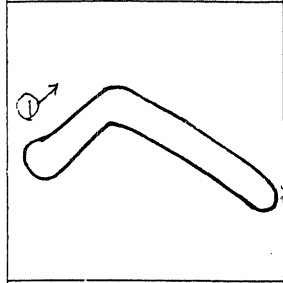
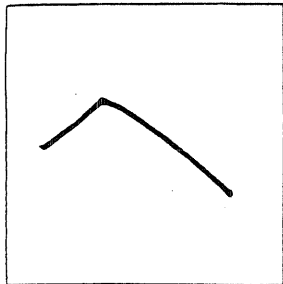

[へ - - -]

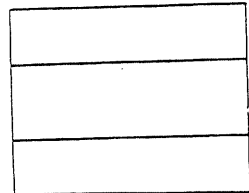

[へ - -]

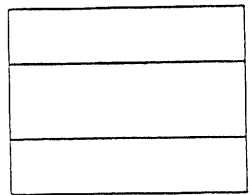
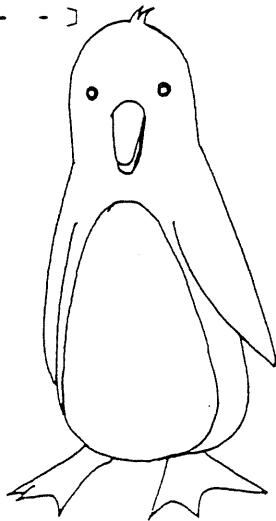

[ぺ - - -]

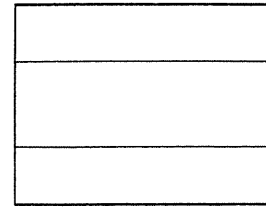

[へ - - -]

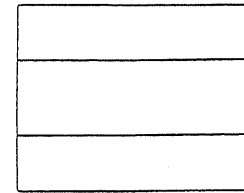

[へ - - -]

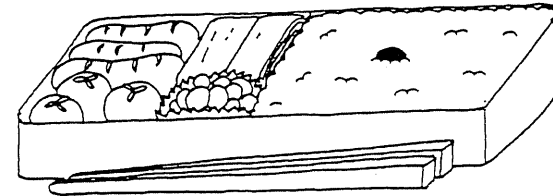

へんじ

べんぎょう

へや

ペンギン [ペンギン]

べんとう



# ほうき

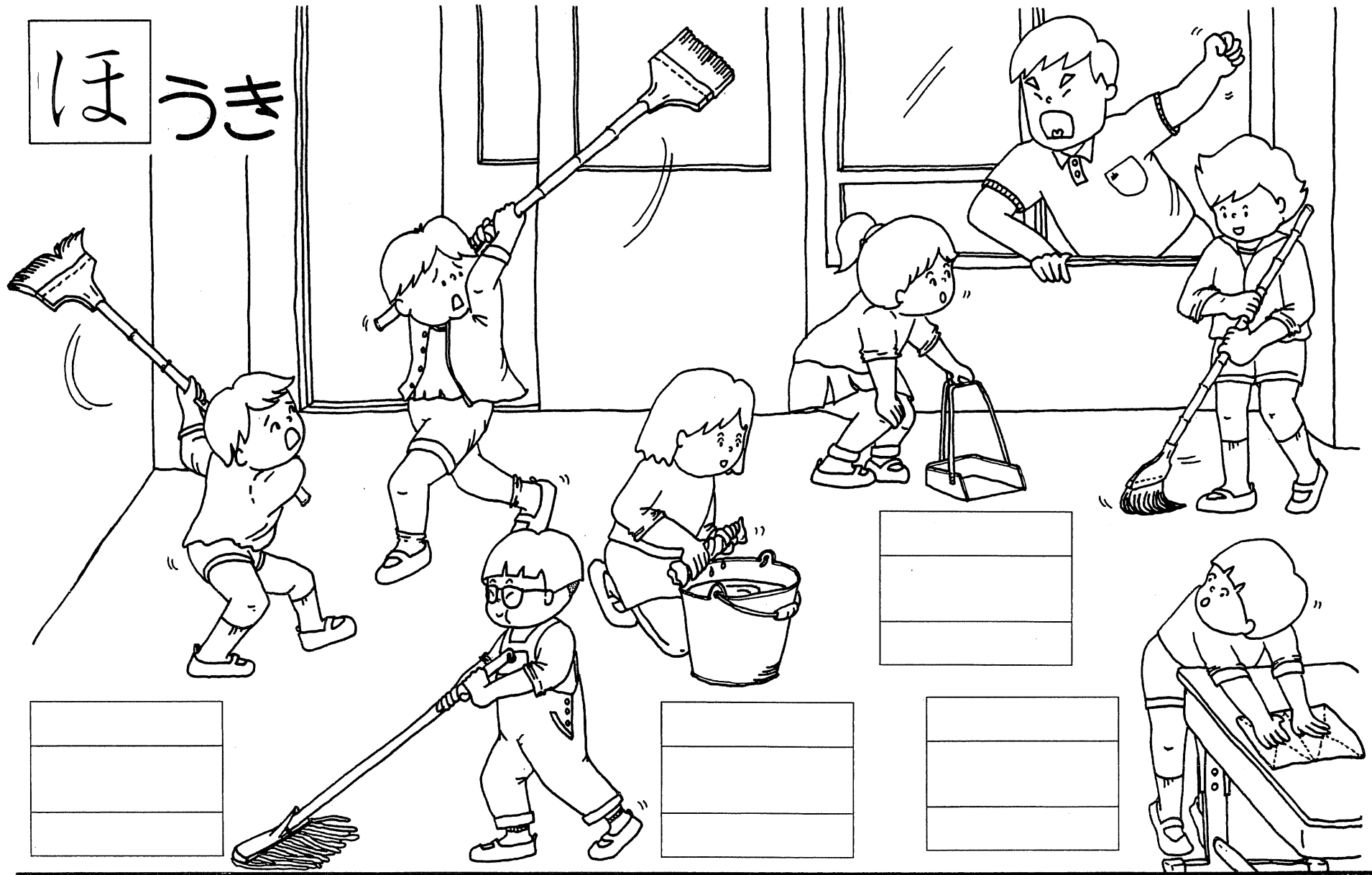

ちりとり  
もっふ(モップ) ばけつ(バケツ) ぞうきん

——で そうじをしましょう。

ほ

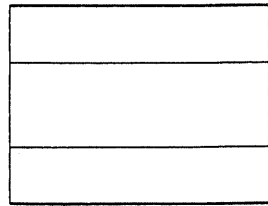

[ほ - -]

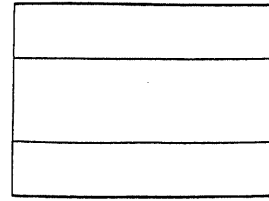

[ほ -]

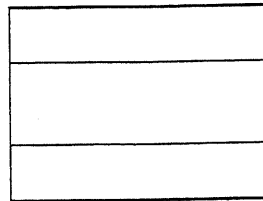
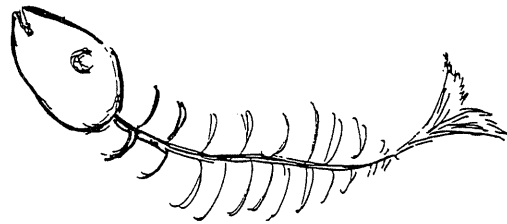
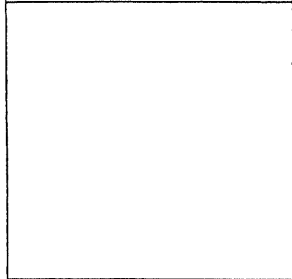
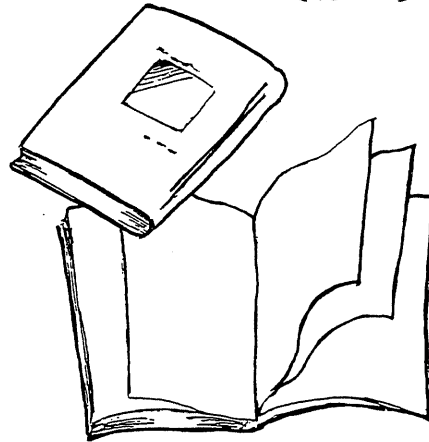
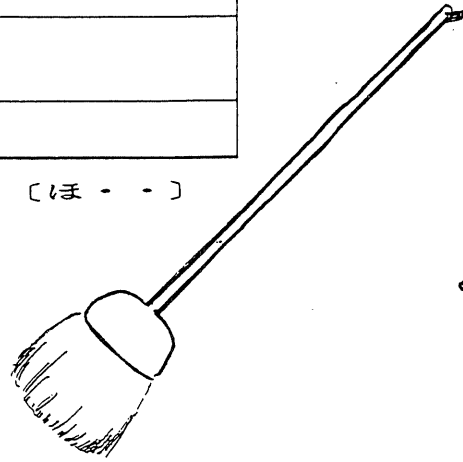
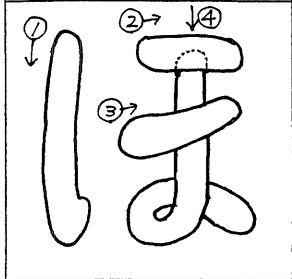
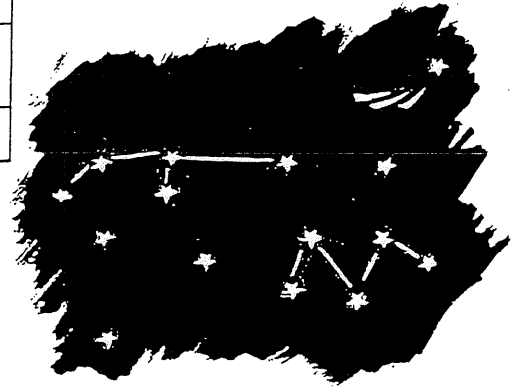

[ほ -]

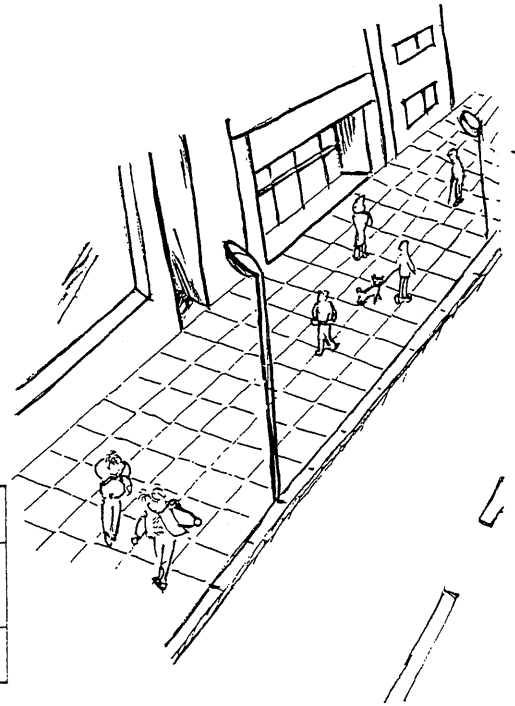

ぼ



ぽ

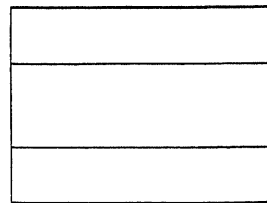

[ほ -]

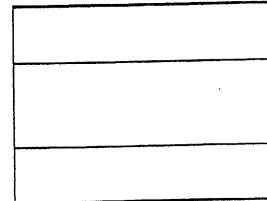

[ほ - -]

ホ ho

ボ bo

ポ po

ほうき

ほね

ほん

ほし

ほどう

まの

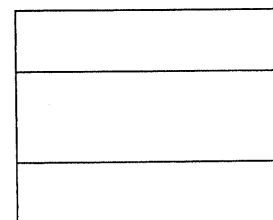
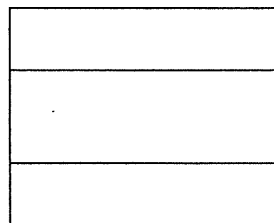
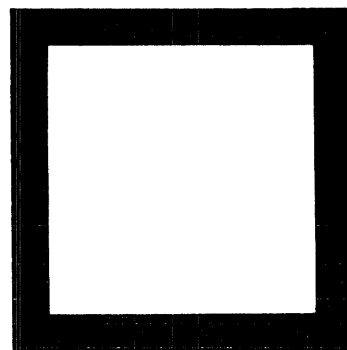
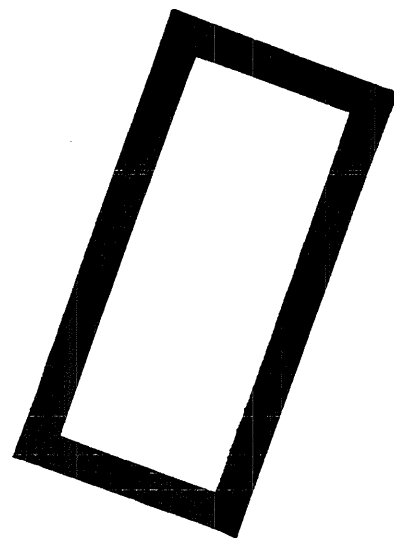
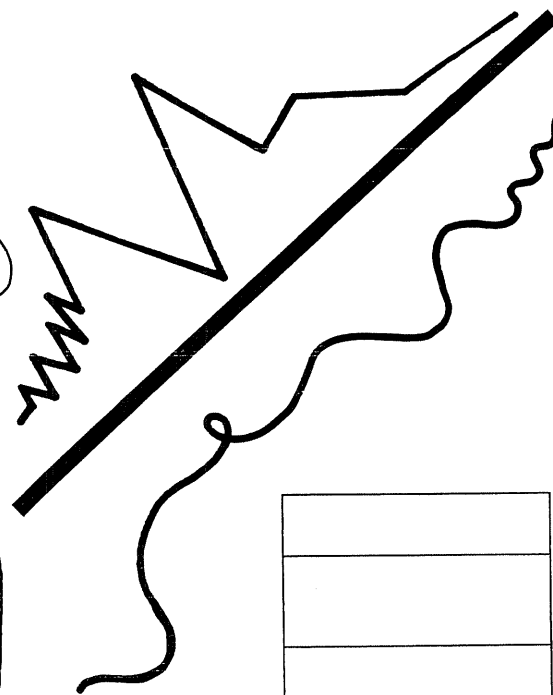
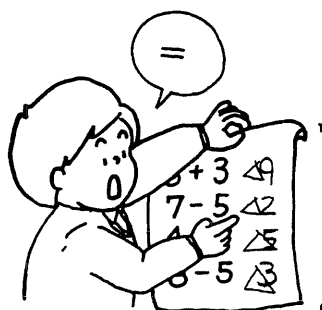
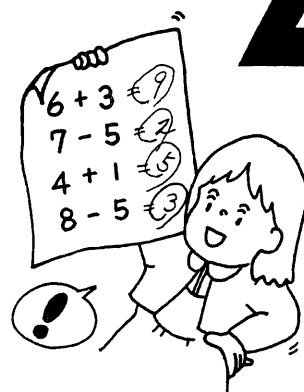
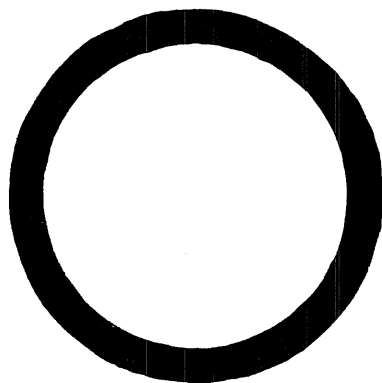
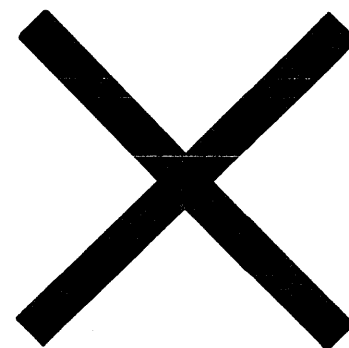
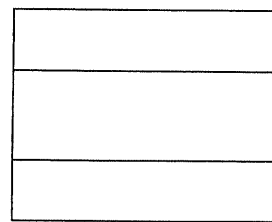
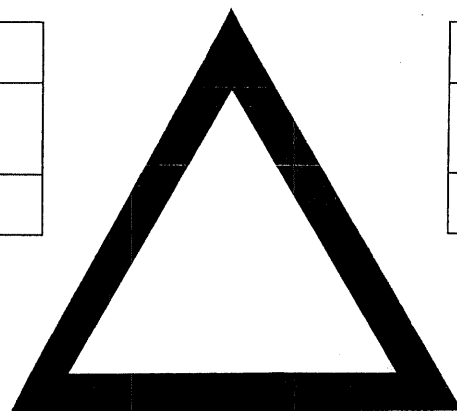
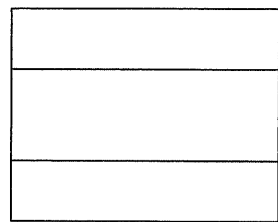

さんかく  
しかく

ぼつ  
せん

ま	
① →	② →
③ ↓	
ま	
ま	ま
マ	ma

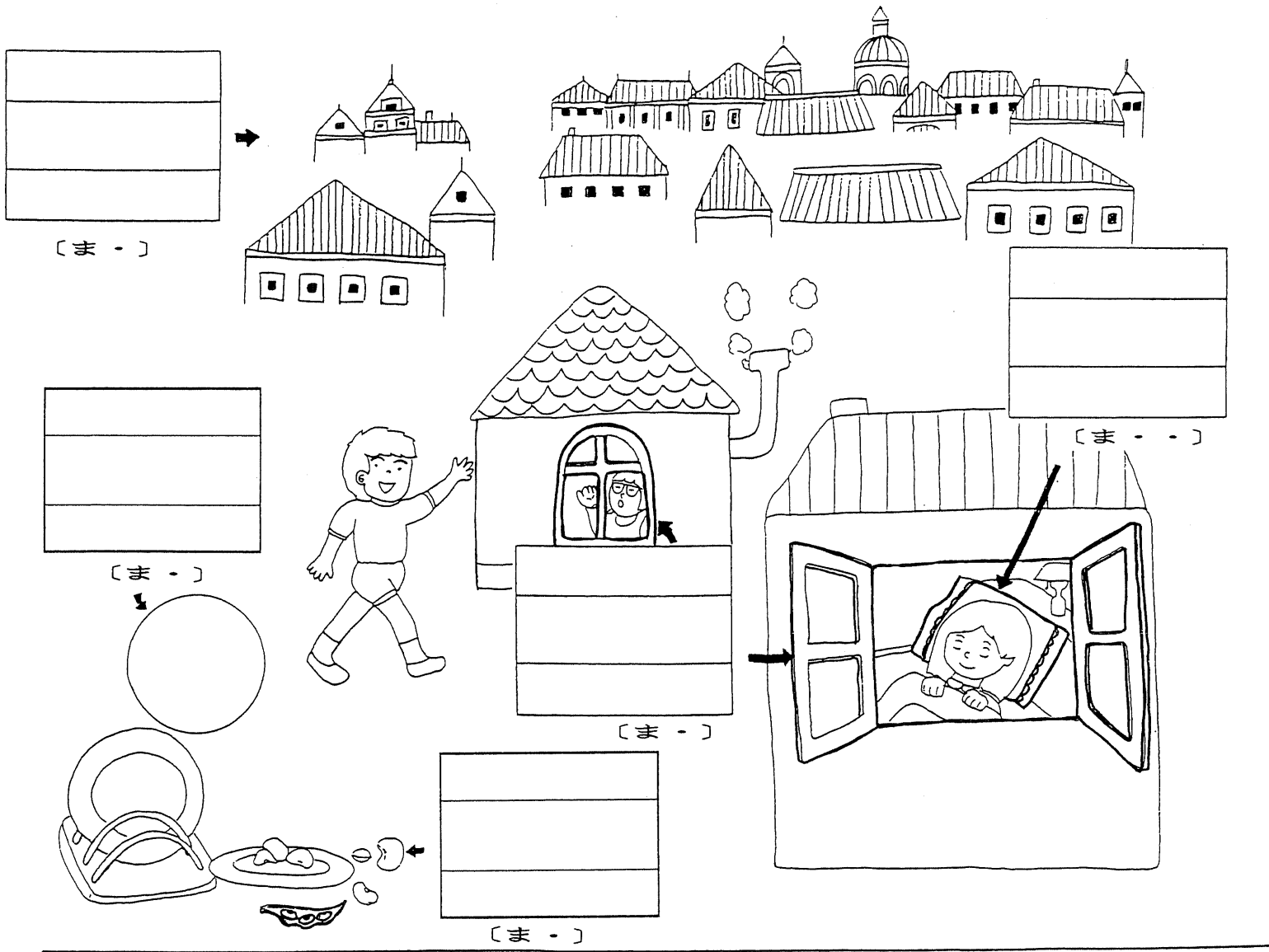

まぢ  
 まる  
 まめ

まど

まくら

# みかん

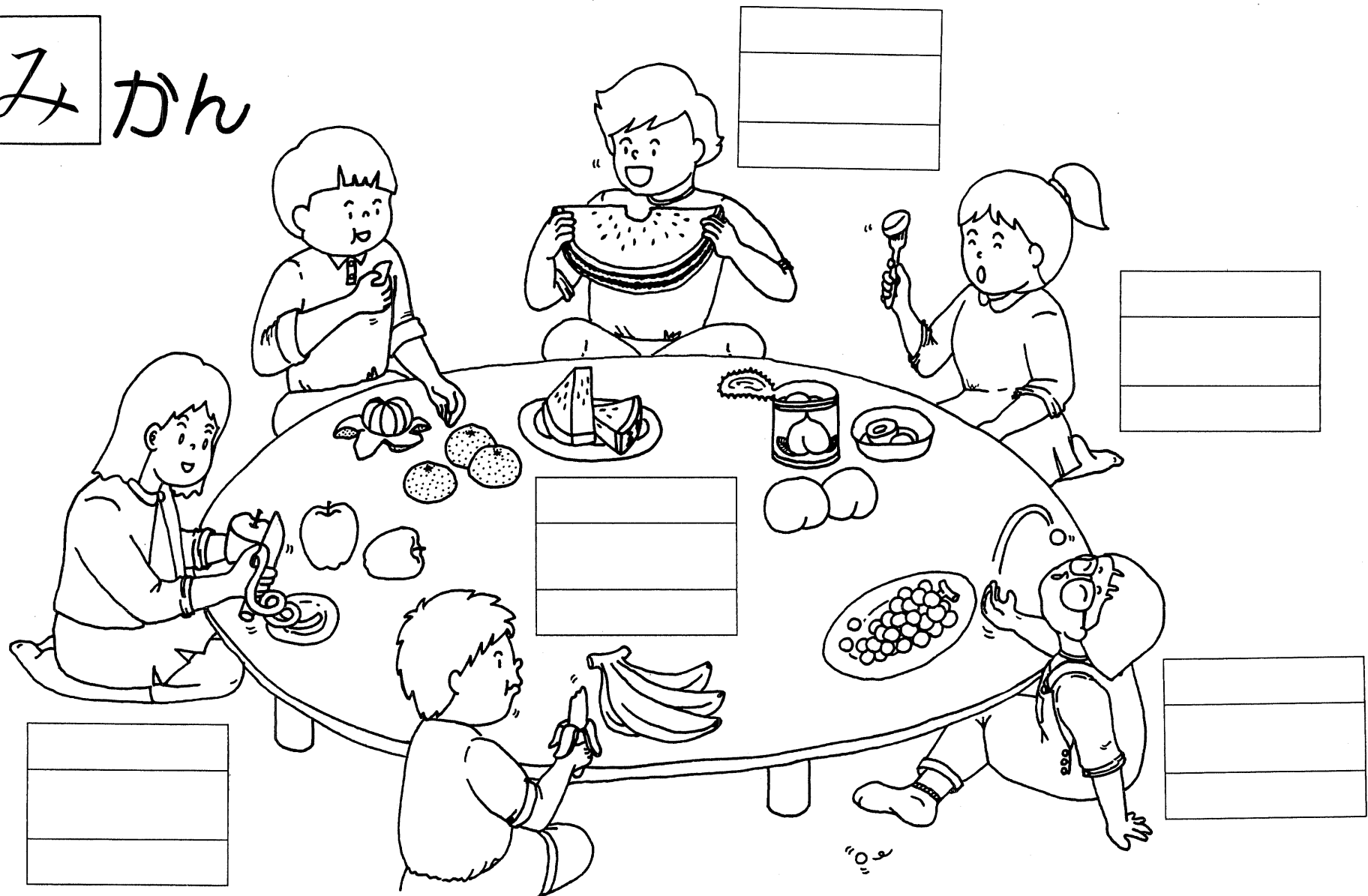

りんご

すいか  
 ばなな (バナ)

もも  
 ぶどう

\_\_\_\_\_がほしいです。

ミ

①  
②

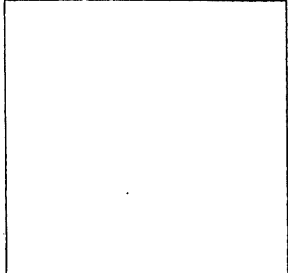

ミ



mi

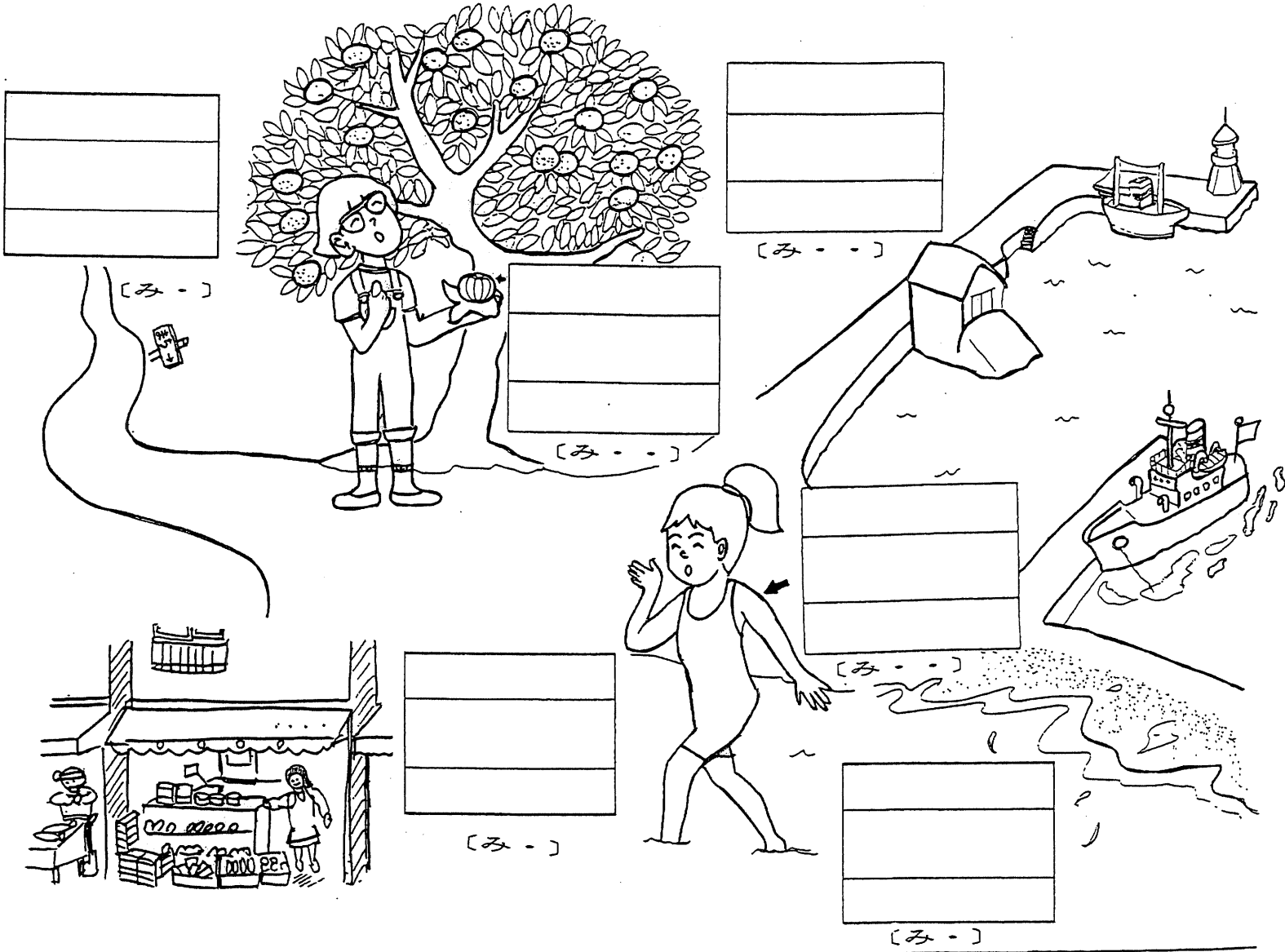

みや (ミヤ)	mya
みゆ (ミユ)	myu
みよ (ミヨ)	myo

みち  
みせ

みかん  
みずぎ

みなと  
みず

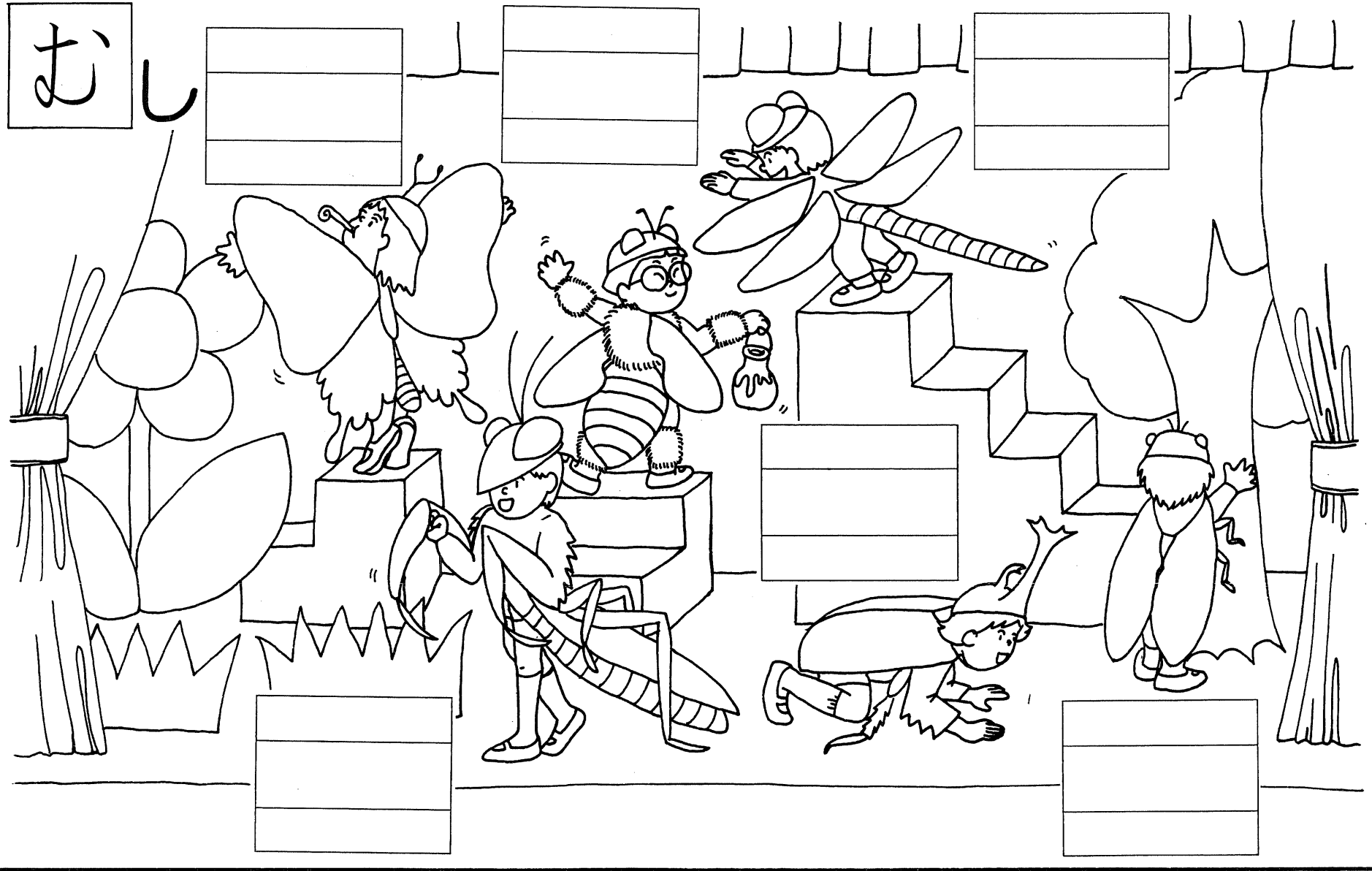

ちょう (ちょうちょう)    はち    とんぼ  
 かまきり    かぶとむし    せみ

む	
△	mu

むしば	むら	むぎ
むしめがね		むし



め





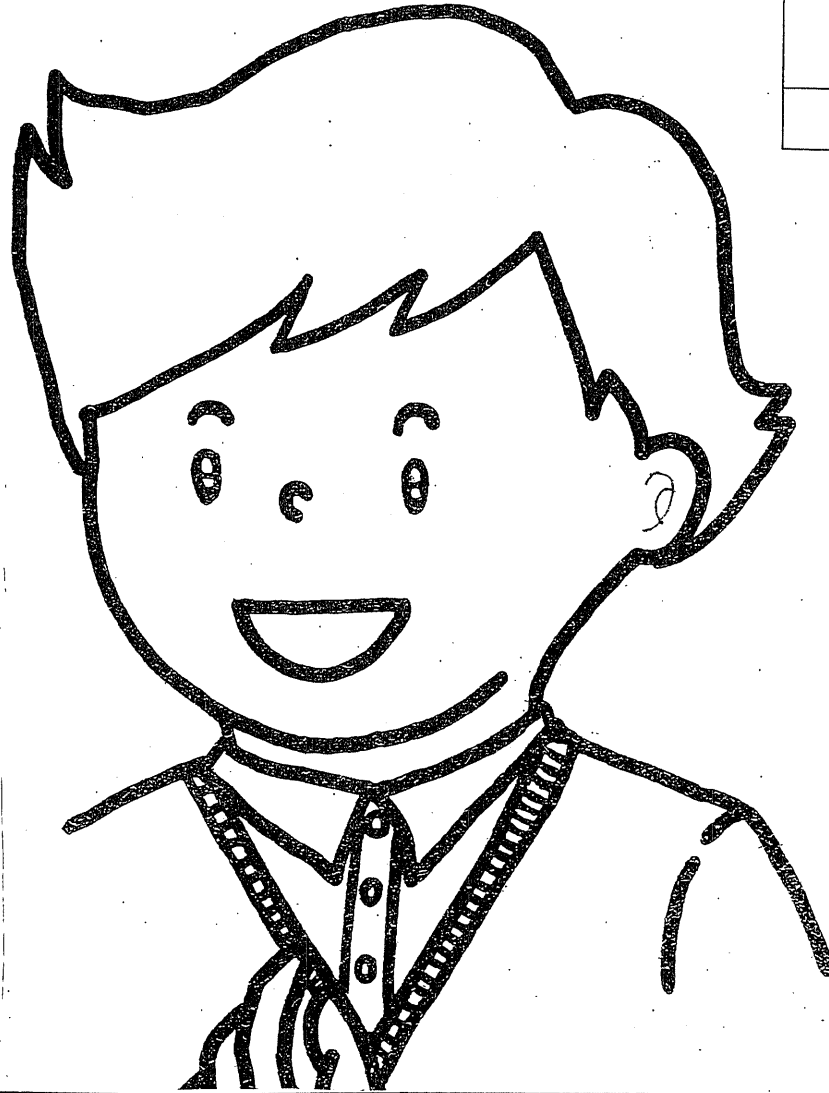



くち

はな  
あご

みみ  
まゆ

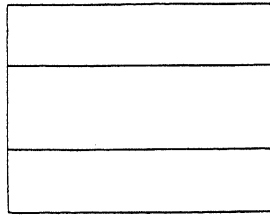
	me



[め]

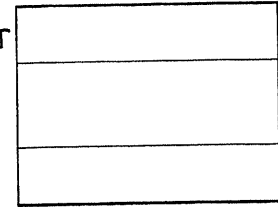
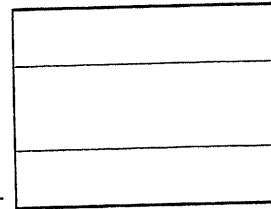

[め-]

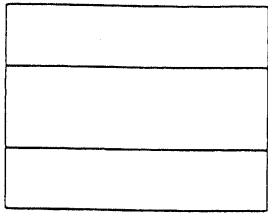

[め...]

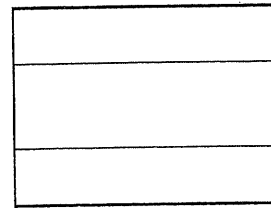
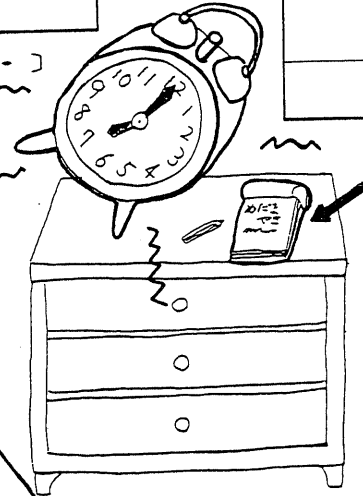

[め.....]

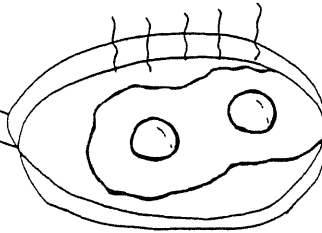

め  
めがね

めざましどけい  
めだまやき

めも [MEMO]

もつきん

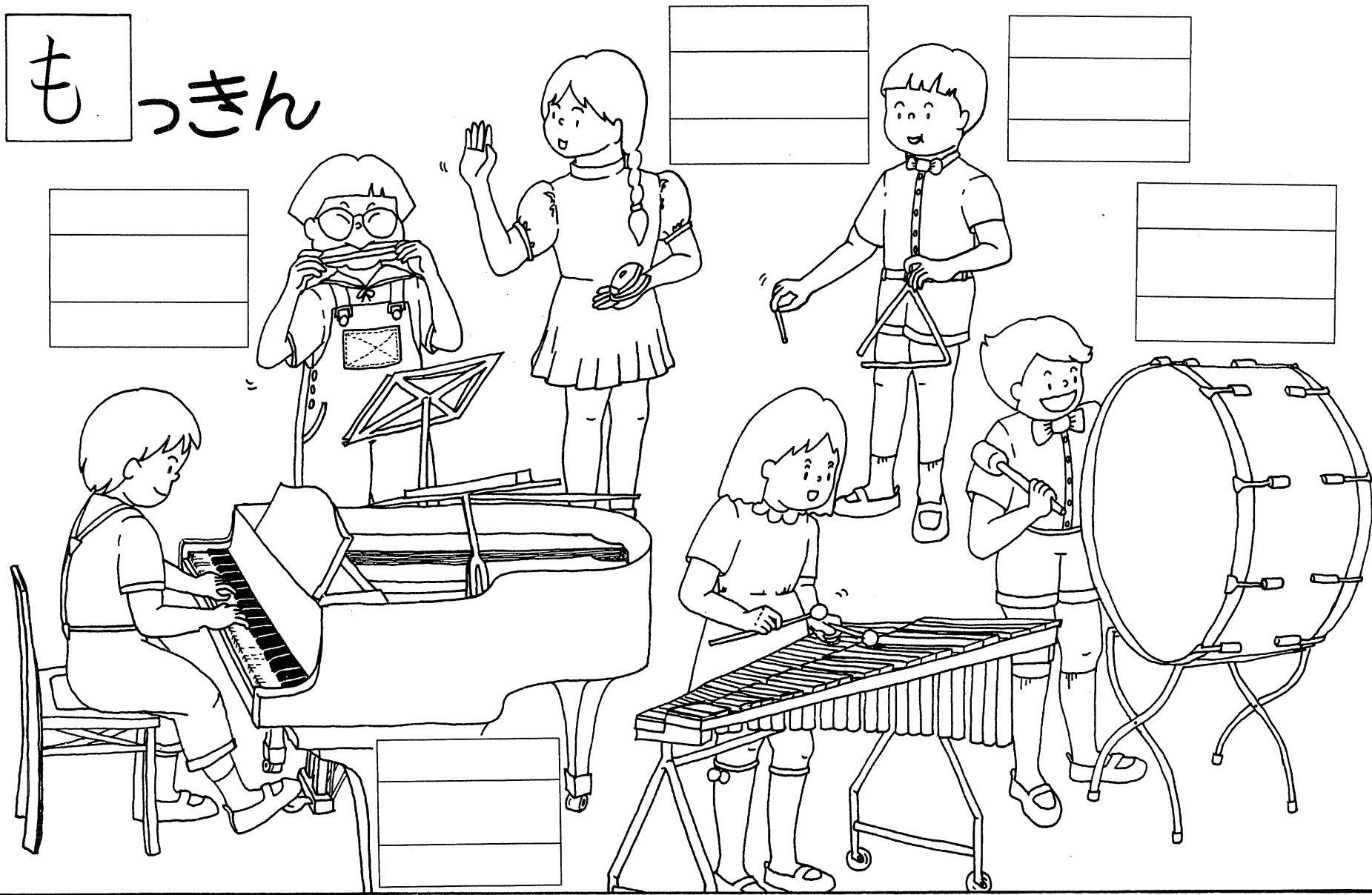

はーもにか (ハーモニカ)    かすたねっと (カステネット)    とらいあんぐる (トライアングル)  
 ぴあの (ピアノ)    たいこ

ひたふえ    きたきん    ままを    すす。    すす。    すす。

も	
<div style="border: 1px solid black; height: 30px; width: 100%;"></div> <div style="border: 1px solid black; height: 30px; width: 100%;"></div> <div style="border: 1px solid black; height: 30px; width: 100%;"></div>	
[も - - -]	
<div style="border: 1px solid black; height: 30px; width: 100%;"></div> <div style="border: 1px solid black; height: 30px; width: 100%;"></div> <div style="border: 1px solid black; height: 30px; width: 100%;"></div>	
[も - ] ↓	
も	
<div style="border: 1px solid black; height: 30px; width: 100%;"></div> <div style="border: 1px solid black; height: 30px; width: 100%;"></div> <div style="border: 1px solid black; height: 30px; width: 100%;"></div>	
[も - -]	
も	mo

[も - - -]

[も - ] ↓

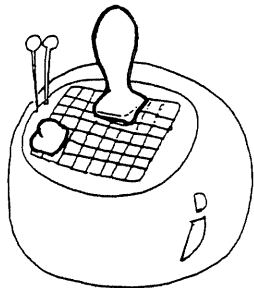

[も - ]



ひがしもん.....

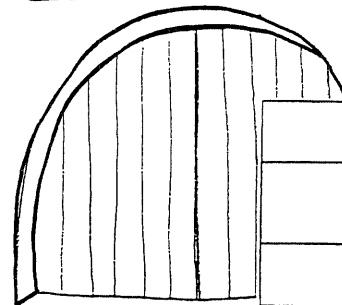

[も - ]



[も - -]

もん

もっきん  
もち

もじ  
もみじ

ま

Blank box for writing

Blank box for writing

Blank box for writing

Blank box for writing

Blank box for writing

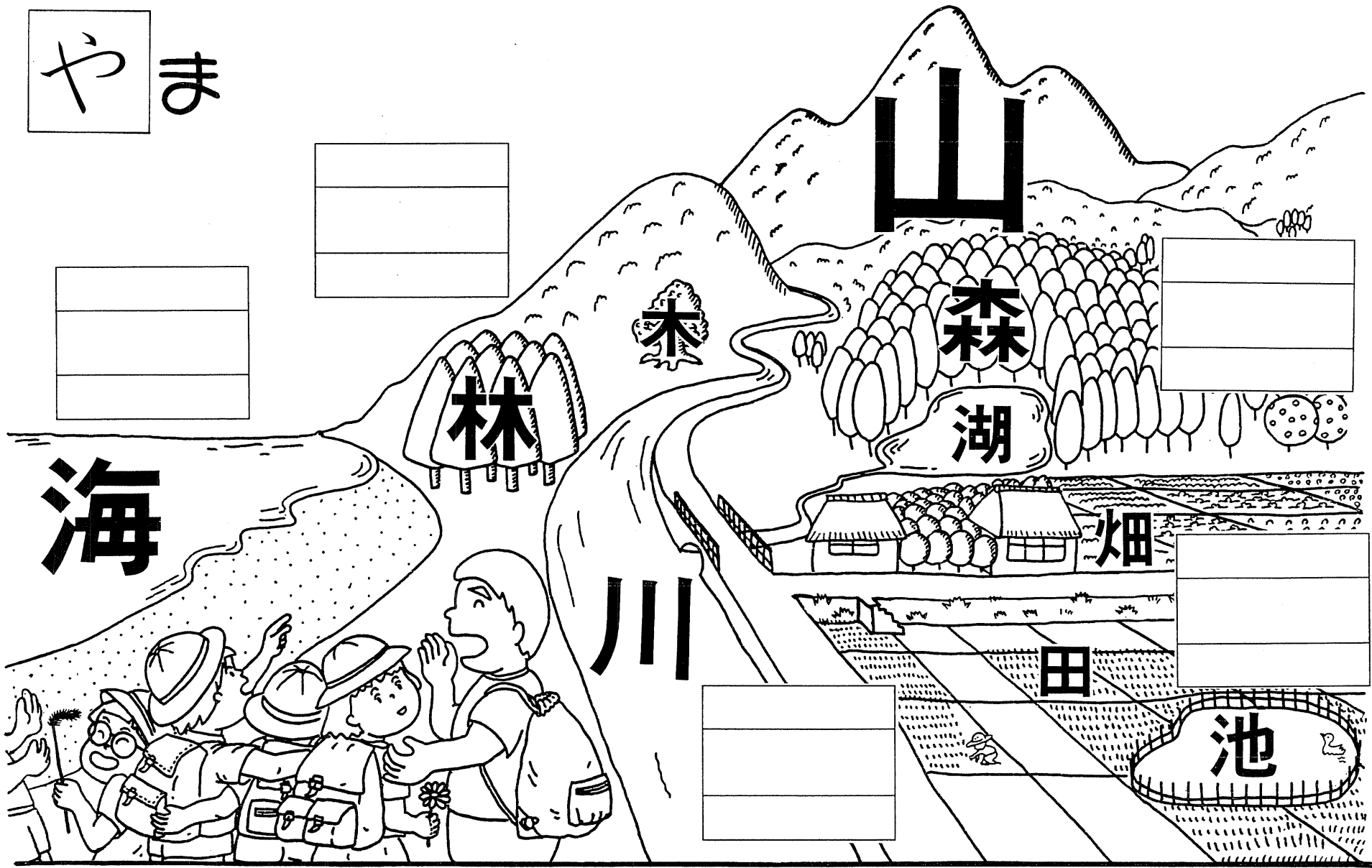

海

林

木

山

森

湖

川

畑

田

池

うみ

はやし

もり

かわ

いけ

海 (うみ)	川 (かわ)	田 (いり)	池 (いけ)	山 (やま)	森 (もり)	湖 (うみ)	畑 (はたけ)
林 (はやし)	木 (き)						

や	
や	ya

[や...]

[や...]

[や...]

[や...]

[や...]

[や...]

やけど                  やま                  やさい  
 やかん                  やね

# ゆうびんきょく



ぎんこう      たてもの      びょういん  
 こうえん      としょかん      えき

——が みえます。

ゆ

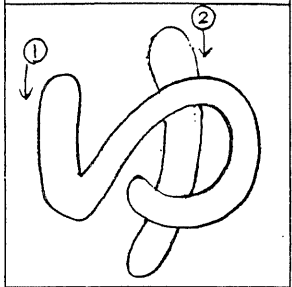

Blank writing lines

ゆ

Blank writing lines

yu



Blank writing lines

[ゆ - -]

Blank writing lines

[ゆ - - - -]

Blank writing lines

[ゆ -]

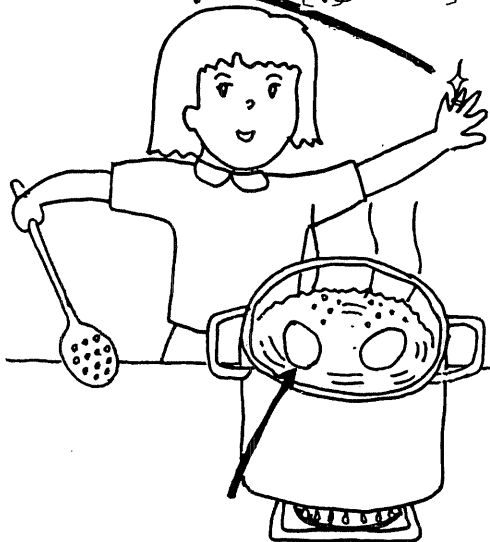

Blank writing lines

[ゆ - - - -]

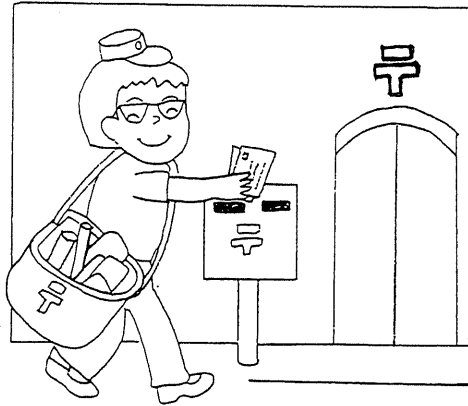

Blank writing lines

[ゆ -]

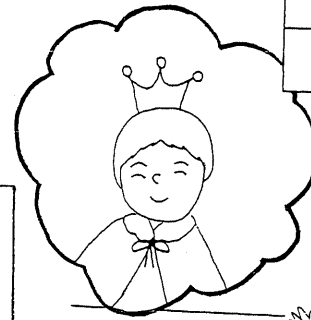

ゆびわ

ゆうびんきょく

ゆめ

ゆでたまご

ゆか



# よ うちえん

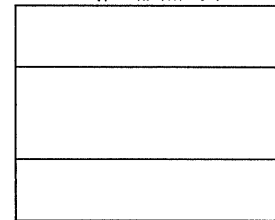
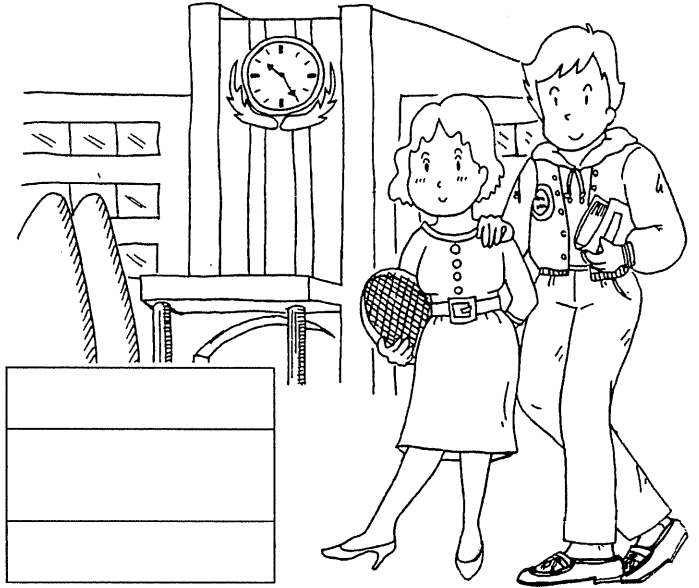
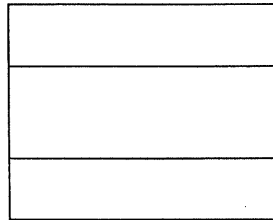
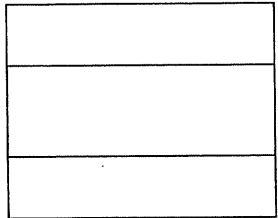
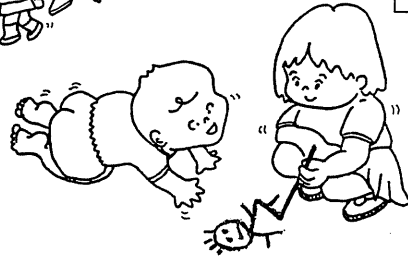
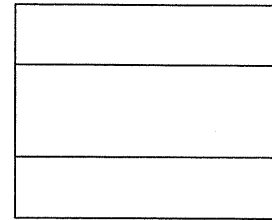
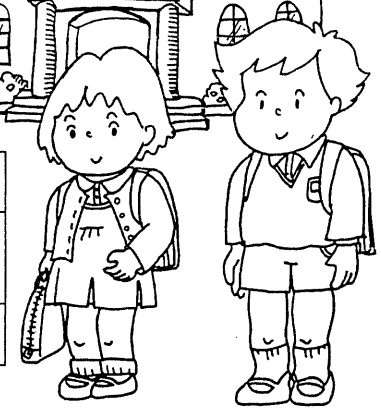
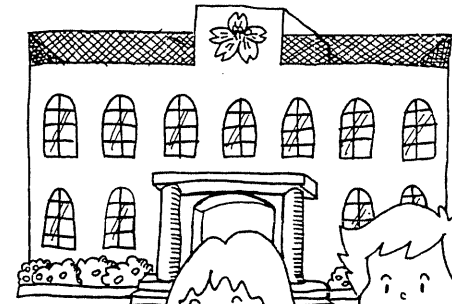
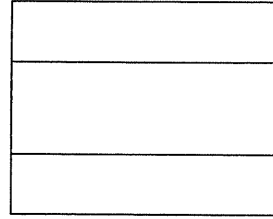
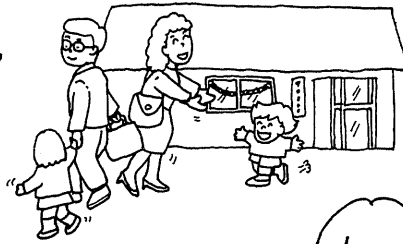
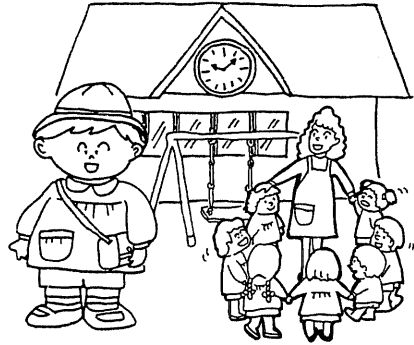

ほいくしょ      しょうがっこう  
 ちゅうがっこう      こうこう      だいがく

<発音>  
 がっこう      が      はじまります。

ヨ	
ヨ	
ヨ	yo

ご用のかたはおして下さい

[ヨ.....]

[ヨ.....]

[ヨ.....]

[ヨ.....]

[ヨ.....]

[ヨ.....]

[ヨ.....]

よびりん

よこづな

ようちえん

よっと [ヨット]

よーぐると [ヨーグルト]

# らんどせる

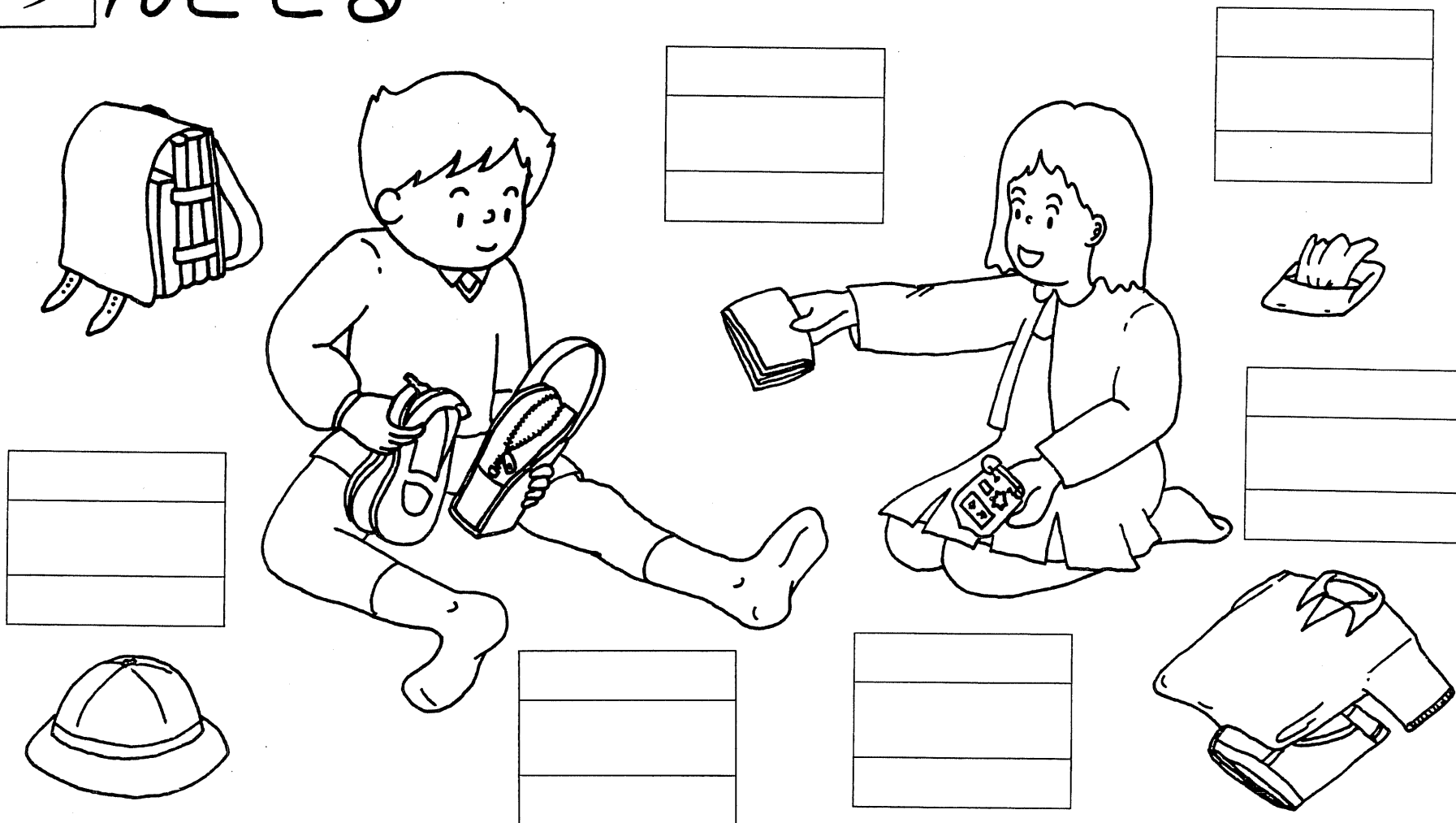

はんかち [ハンカチ]    ていっしゅ [ティッシュ]  
 うわぐつ    なふだ  
 ぼうし    たいそうふく

<発音>  
 \_\_\_\_\_ を もちました。 [↘]  
 \_\_\_\_\_ を もちました(か)。 [↗]

ら	
①	②
ら	
ら	
ら	ra

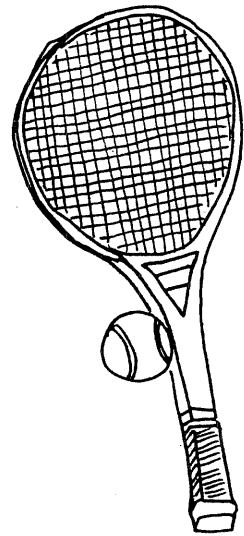

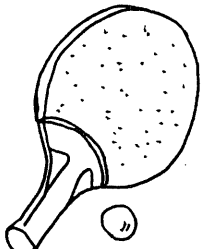

[ら - - -]



[ら - - -]

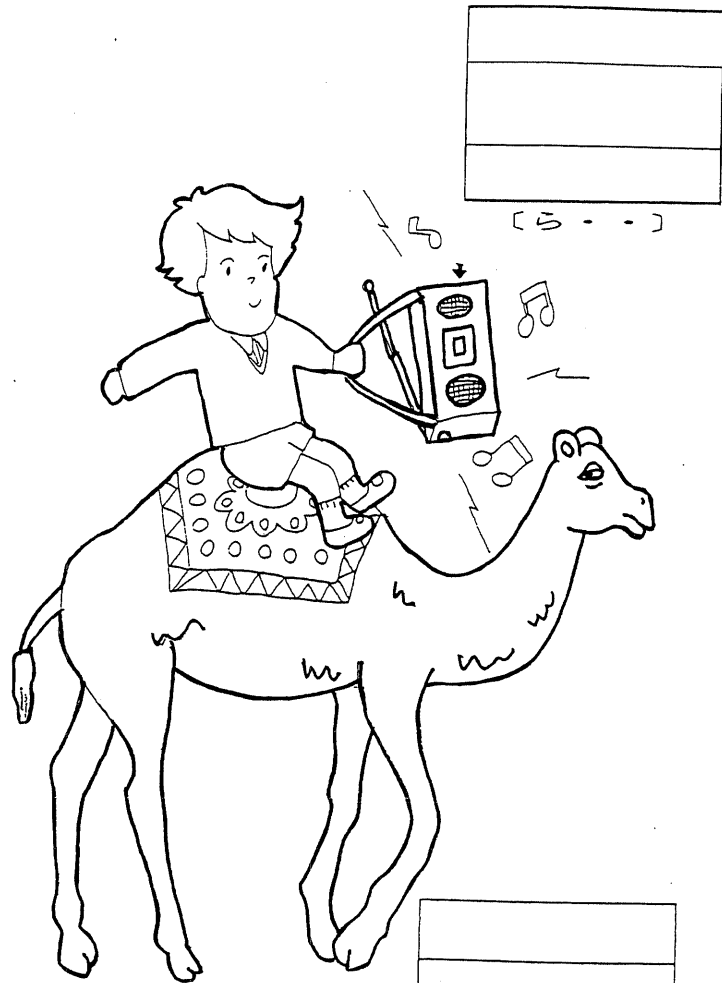

[ら - - -]



[ら - -]

[ら - -]

らけつと (ラケット)

らじお (ラジオ)

らんどせる (ランドセル)

らくだ (ラクダ)

らーめん (ラーメン)

り

りゅくさっく

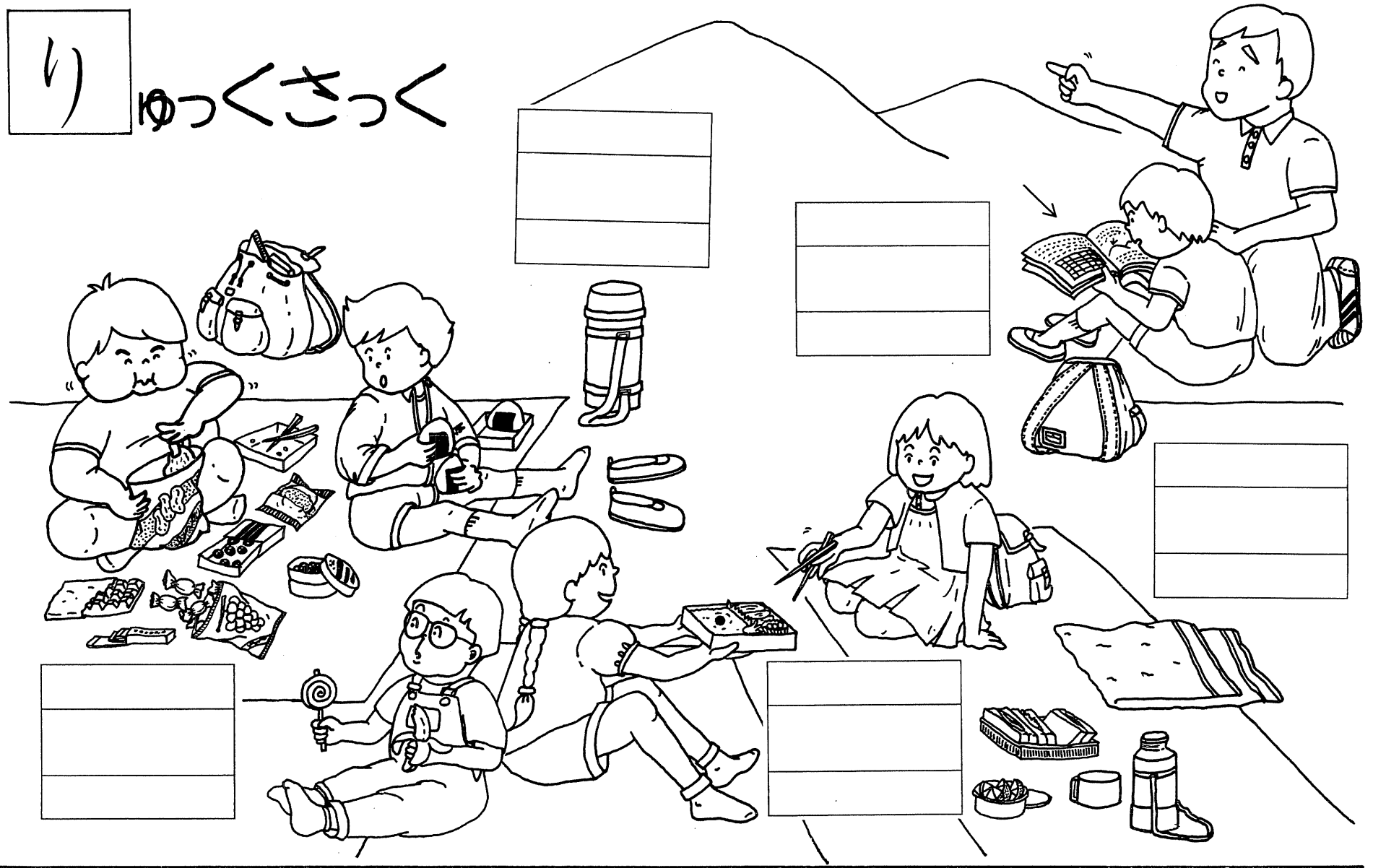

おやつ

すいとう

べんとう

しおり

たおる (タオル)

<発音>  
りゅく - りゅく - りゅっく

り

Blank writing lines for the character 'り'.

[り - -]

1 2  
り



Blank writing lines for the character 'り'.

[り -]

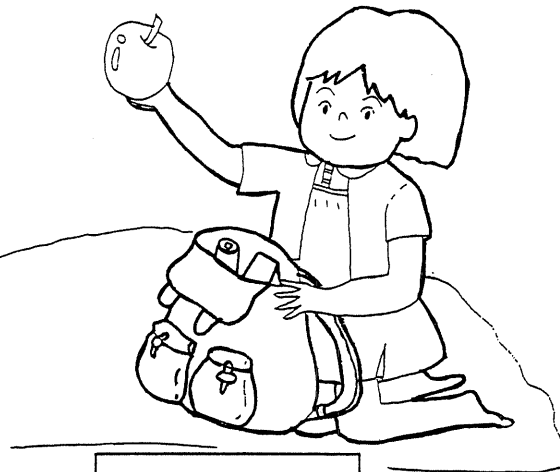

Blank writing lines for the character 'り'.

[りゅ - - - -]

Blank writing lines for the character 'り'.

[りょ - -]



り

り

り ri

りゃ (りゃ)	rya
りゅ (りゅ)	ryu
りょ (りょ)	ryo

りぼん (りぼん)

りす りゅっくさく (リュックサック) りょこう

る

る

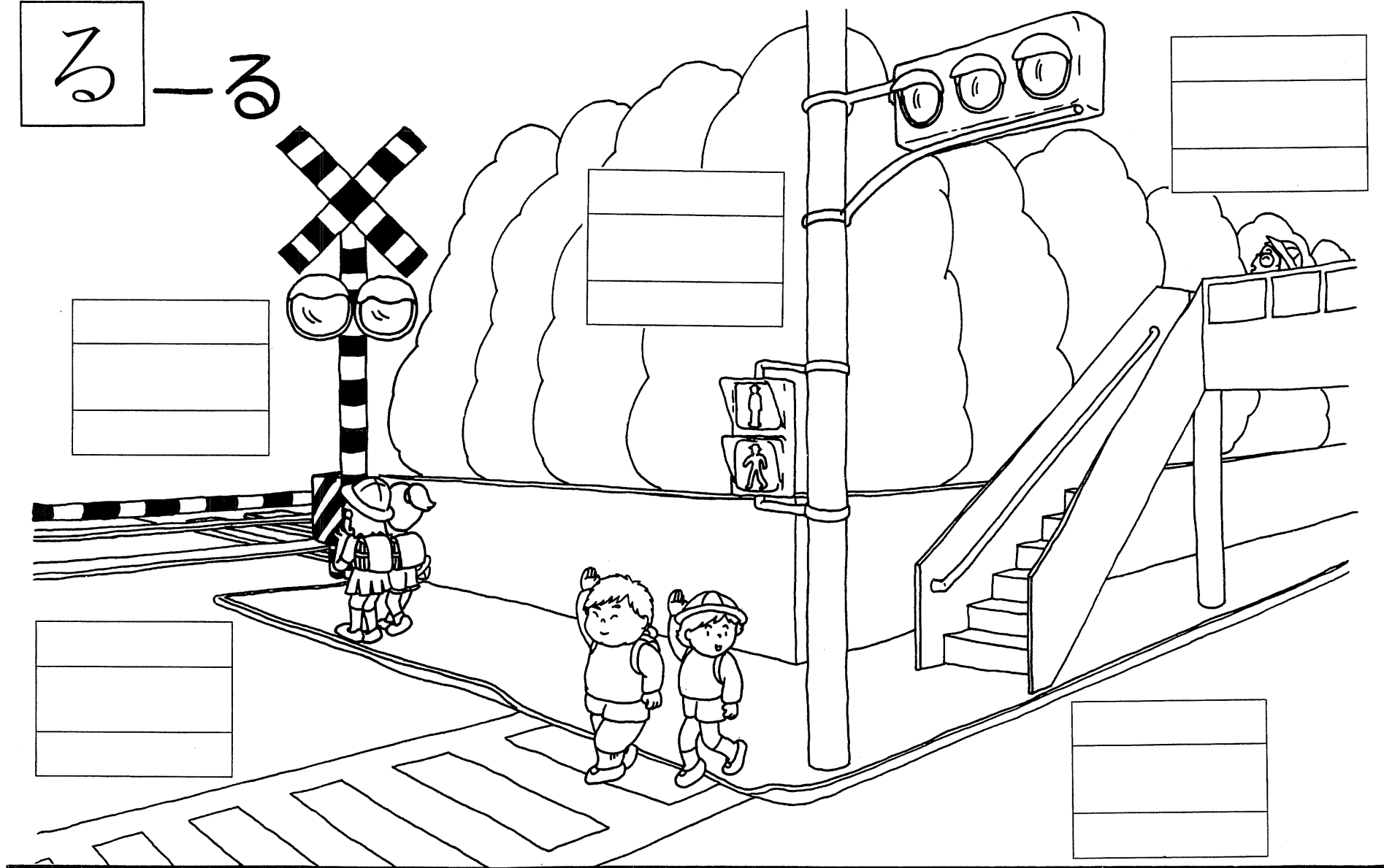

ふみきり    しんごう    ほどうきょう  
 おうだんほどう    こうぎてん

<発音>    ルール    ヌーヌ

る	
①	る
	る
ル	ru

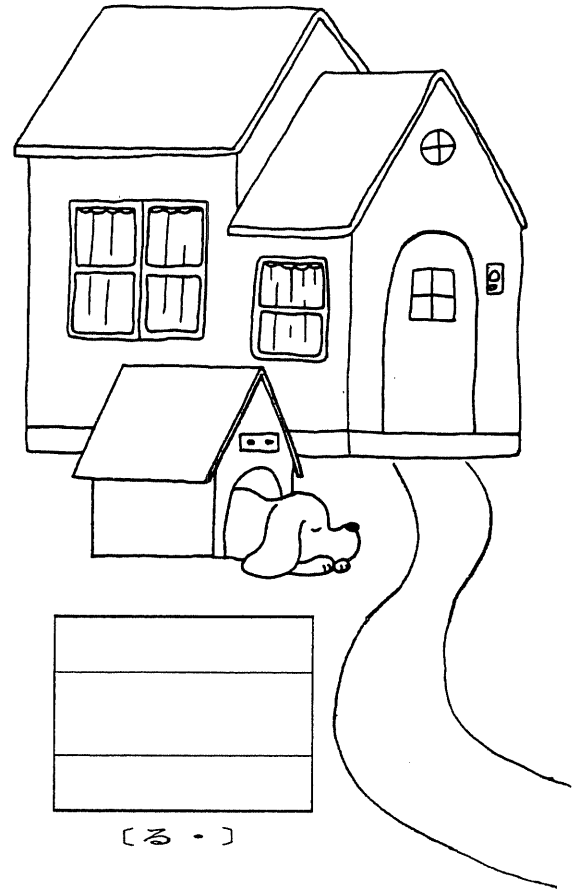

るーる [ルール]

るす



# れいぞうこ

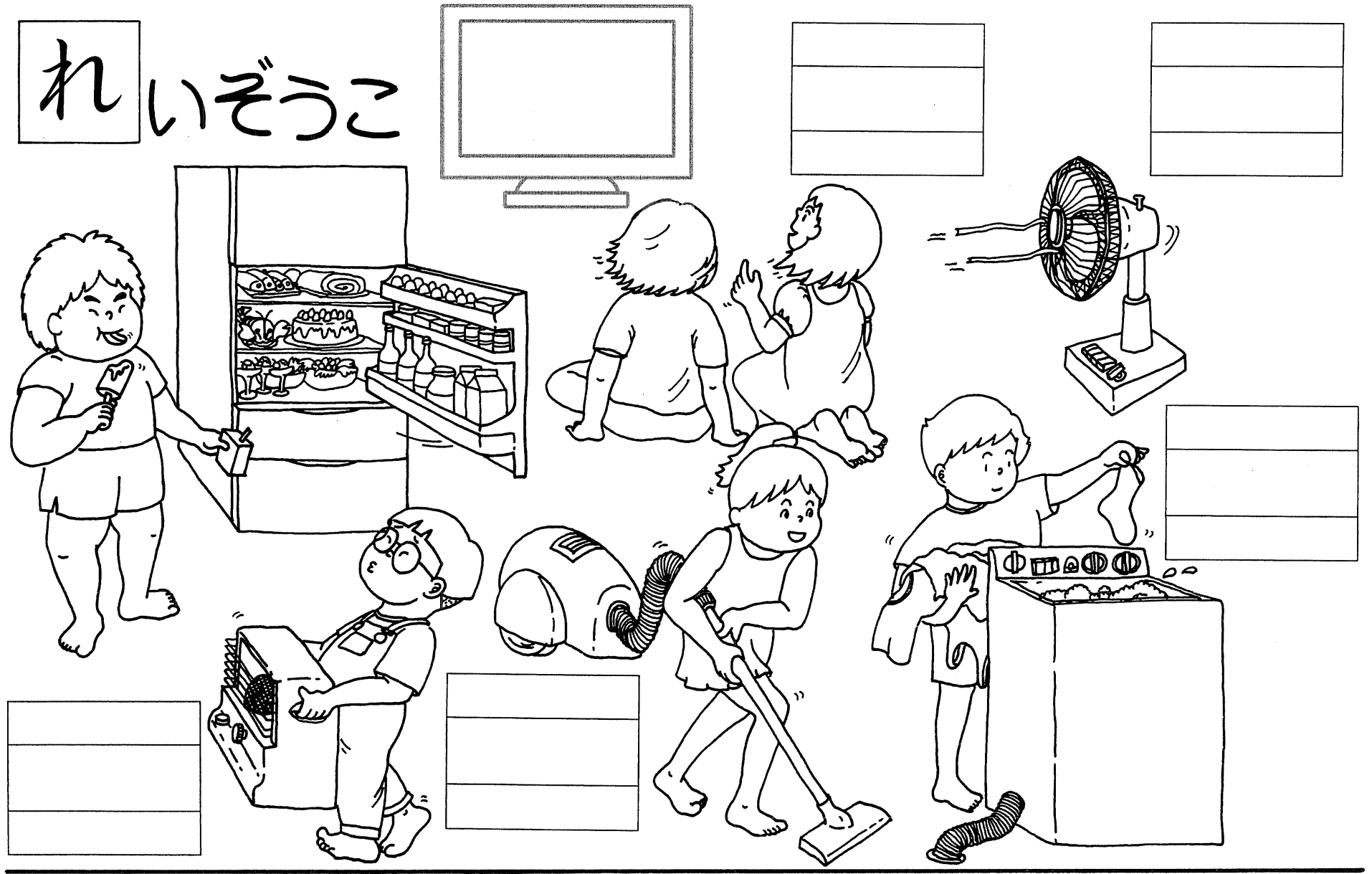

テレビ (テレビ)      せんぷうき  
すとーぶ (ストーブ)      そうじき      せんたくき

れ	
れ	
レ	re

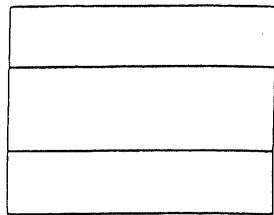

[れ - - - -]

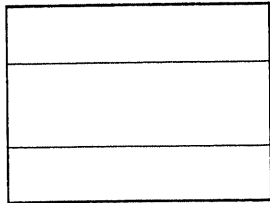
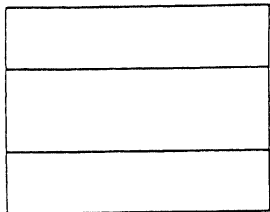

[れ - -]

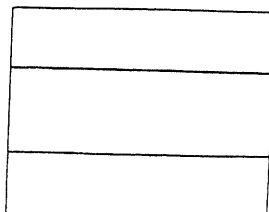

[れ - - - -]

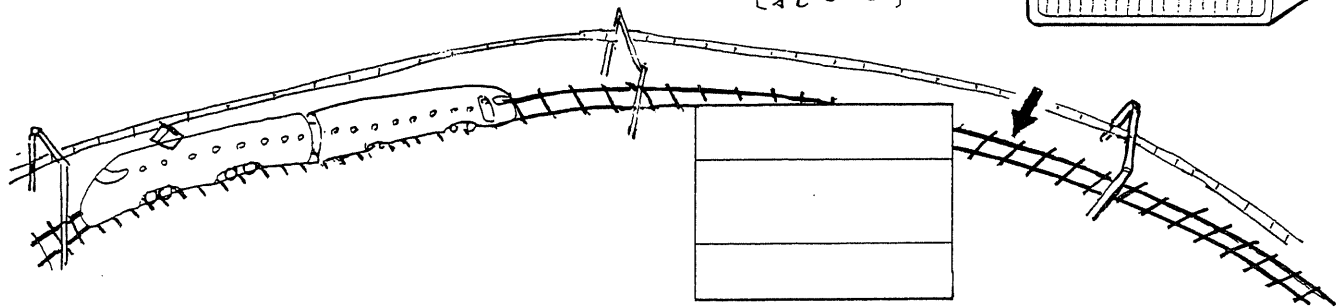
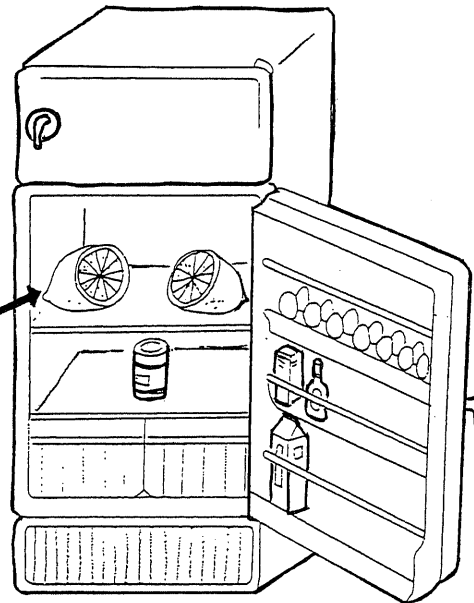

[れ - -]

れすとらん (レストラン)

れもん (レモン)    れいぞうこ

れーる (レール)

# ろうか

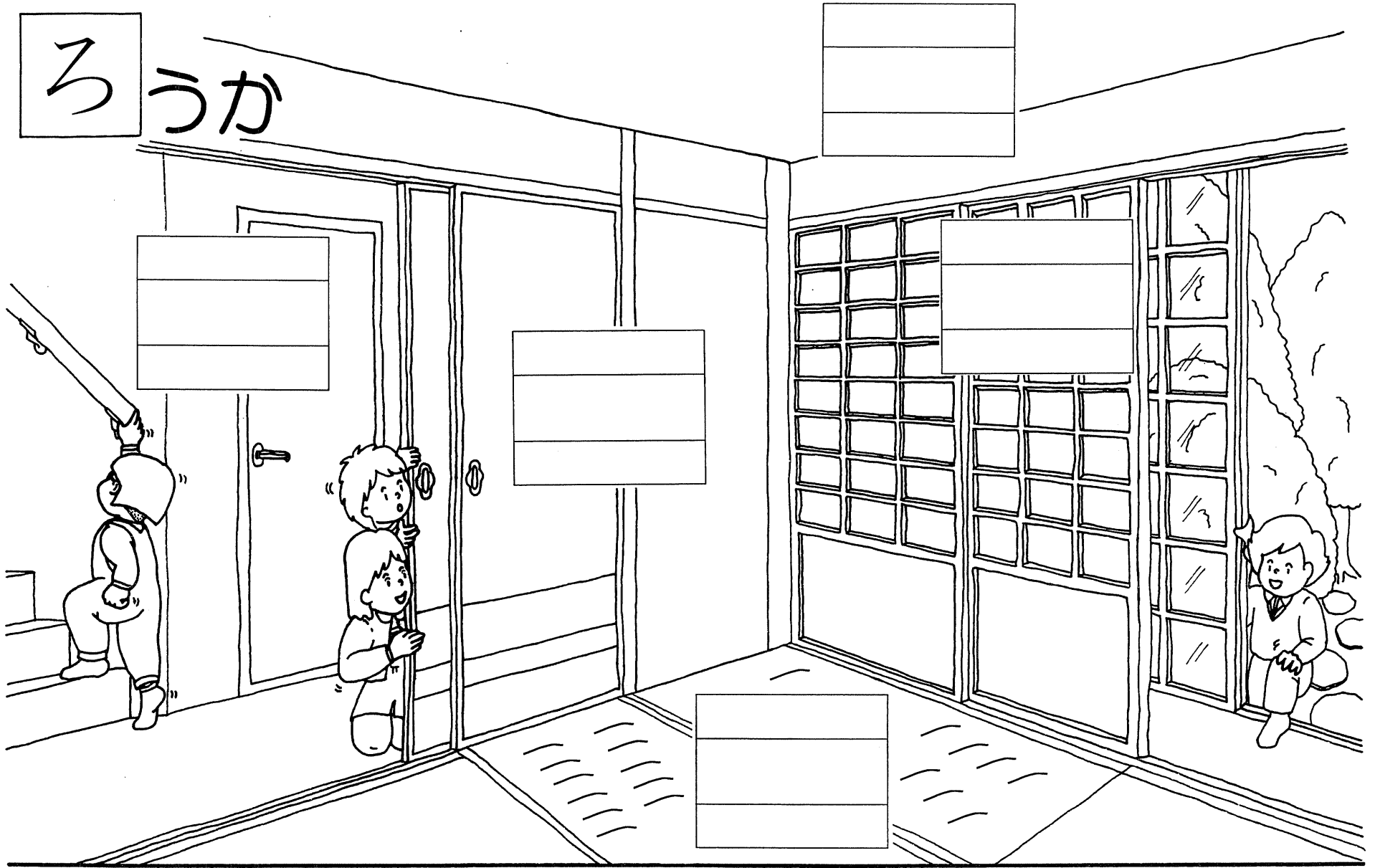

と ふすま てんじょう しょうじ  
たたみ

<発音>  
ろうかーおねえさんーごおり

ろ	
ろ	
ろ	
□	ro

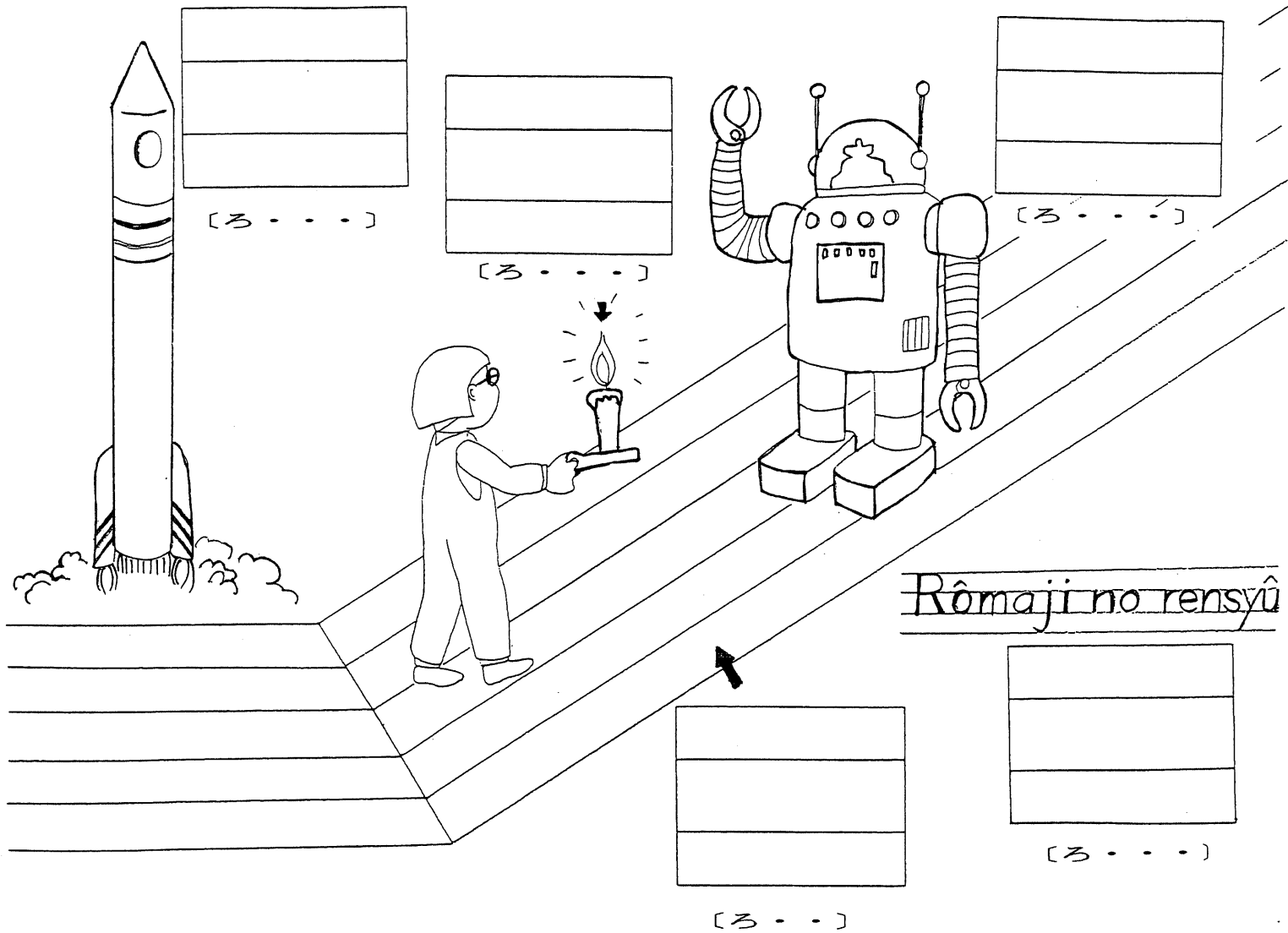

ろけっと (ロケット)   ろうそく   ろぼっと (ロボット)  
                          ろうか                   ろーまじ (ローマじ)

わたし



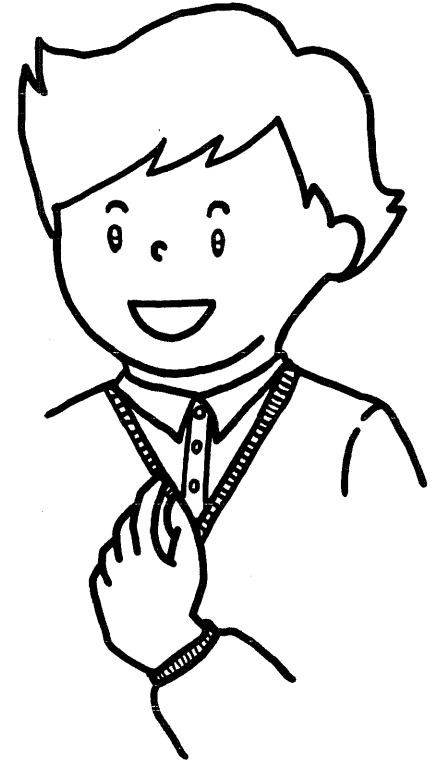
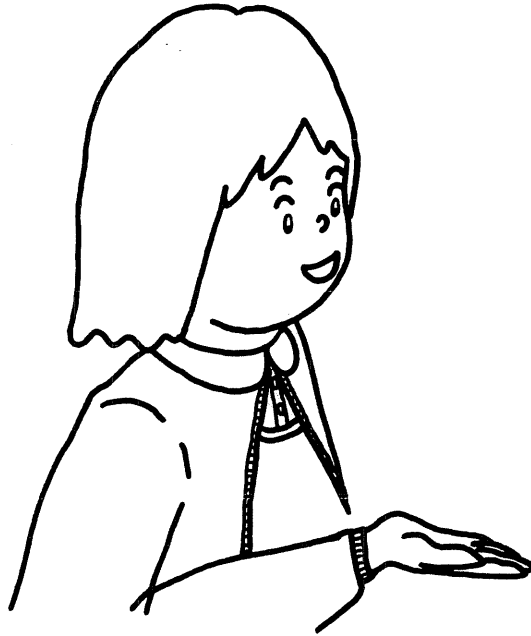

あなた きみ ぼく

わ

わ

わ

わ

わ

ワ wa

[わ...]

[わ...]

[わ...]

[わ...]

[わ...]

[わ...]

[わ...]

[わ...]

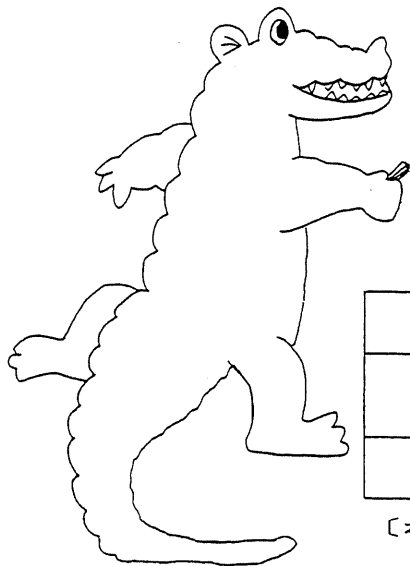

$10 \div 2 = 5$

$12 \div 4 = 3$

$9 \div 3 =$

[わ...]

[わ...]

[わ...]

[わ...]

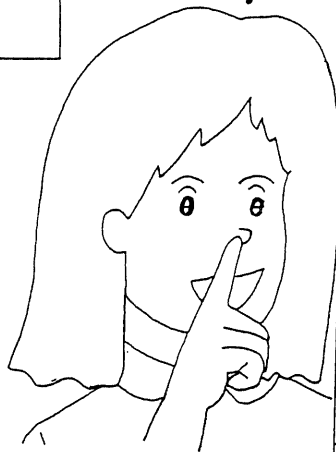

わたし

わたしたち

わいシャツ (ワイシャツ)



わに

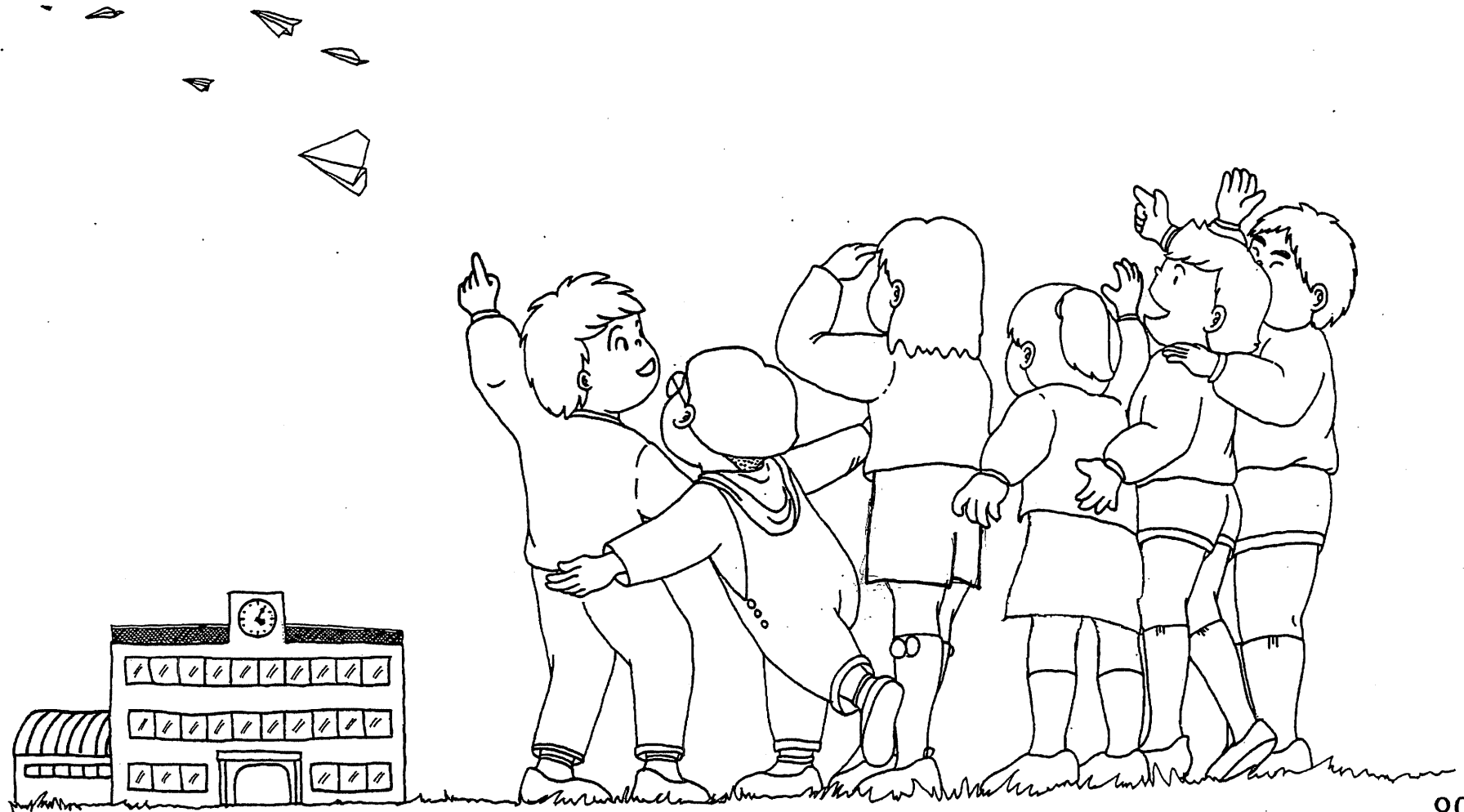

わりざん

わごむ (わゴム)

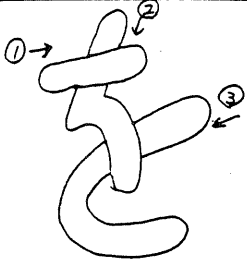
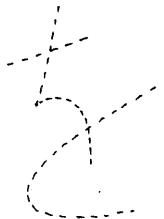
み<sup>ん</sup>なで かみひこうきを<sup>を</sup> とばそう。

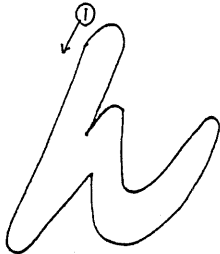

を	
	
	
	
ヲ	(w)o

ん	
	
	
ン	n



[ - ん ]

[ き (気) を つ ける ]

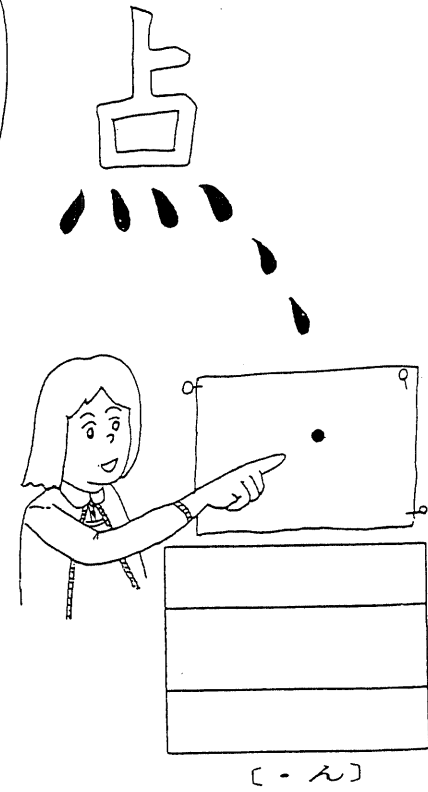

占

[ - ん ]

びん      き (気) を つ ける      てん



用意するもの

①

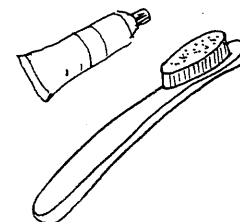
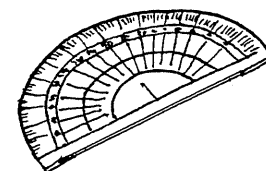
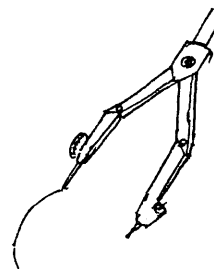
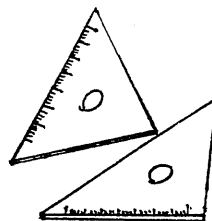
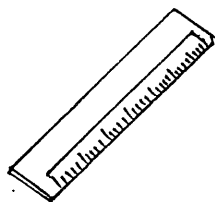
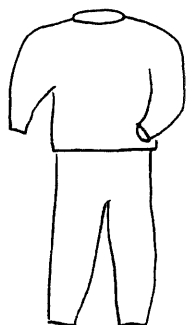
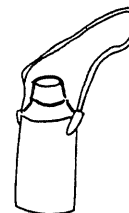
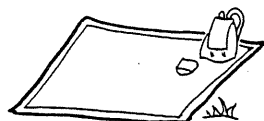
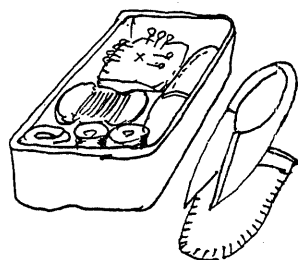
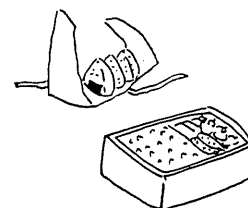
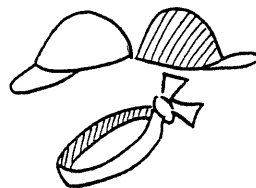
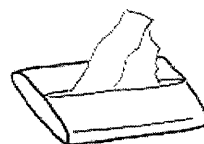
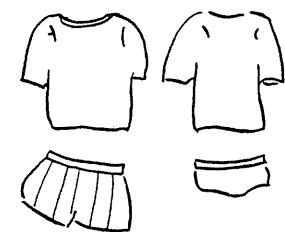

- (1) 切り離して使う。
- (2) 裏側に「3」か国語対訳「き」を貼る。
- (3) 必要に応じて指導書の「3」か国語対訳集「3」を利用してカードを補充してください。

べんとう

ホーファン  
飯盒  
ラン  
lanche  
ドジョコ  
do giò com

ぼうし

マズ  
帽子  
シャペウ  
chapeu  
ノ  
nón

はちまき

ていっしゆ  
[ティッシュ]  
ショウジ  
手紙  
パペル  
papier  
ジヤウミ  
giấy lau mũi

たいそうふく

エントイ  
運動衣  
コバダ  
roupa da  
イロカサシヨウ  
educação física  
クワテ  
quân áo thể dục

したぎ

ハイ  
內衣  
コバダ  
roupa - branca  
クワテ  
quân áo trong

あまぐ

カイン  
雨衣  
カバダ  
capa da chuva  
アム  
áo mưa

かさ

カ  
傘  
ガード  
guarda-chuva  
カイ  
cai o

すいとろ

スイト  
水筒  
カテウ  
cantil  
ビン  
bìn nước

りゅっくさっく  
(リュックサック)

ベカ  
背囊  
モチ  
mochila  
バロ  
ba lô

しーと  
(シート)

テイソ  
墊布  
ポルハ  
Polha de plastico  
パラ  
para sentarse  
タム  
Tam trai

さいほうどうぐ

セイヨウ  
縫纫用具  
コト  
caixa de costura  
ドカ  
đồ khâu

ぶんどき

リヤン  
量角器  
トランスフェル  
transferidor  
\*\*\*

こんぱす  
(コンパス)

コンパス  
圓規  
コンパス  
compasso  
カイ  
cái com-pa

さんかく  
じょうぎ

サンカク  
三角板  
ヘガ  
regua de triangular  
トウカ  
thước kẻ hình tam giác

ものさし

チ  
尺  
ヘガ  
regua  
トウカ  
thước kẻ

ぱじゃま  
(パジャマ)

スイイ  
睡衣  
ピジャマ  
pijama  
クワン  
quan áo ngủ

はぶらし  
(はブラシ)

ヤシ  
牙刷子  
エスコバ  
escova de dente  
バン  
ban chải danh rang

えぶろん  
(エプロン)

エイ  
圍裙  
アベ  
avental  
カイ  
cái tạp de

ぷりんと  
(プリント)

イン  
印刷品  
インプレッション  
impressão  
ソ  
số liên lạc

なふだ

シ  
名牌  
クラ  
cracha  
\*\*\*

うわぐつ

シ  
室内鞋  
サパ  
sapatilha  
ジヤウ  
giày đi trong phòng

おたより・おてがみ  
も、つかわれます。

用意するもの

②

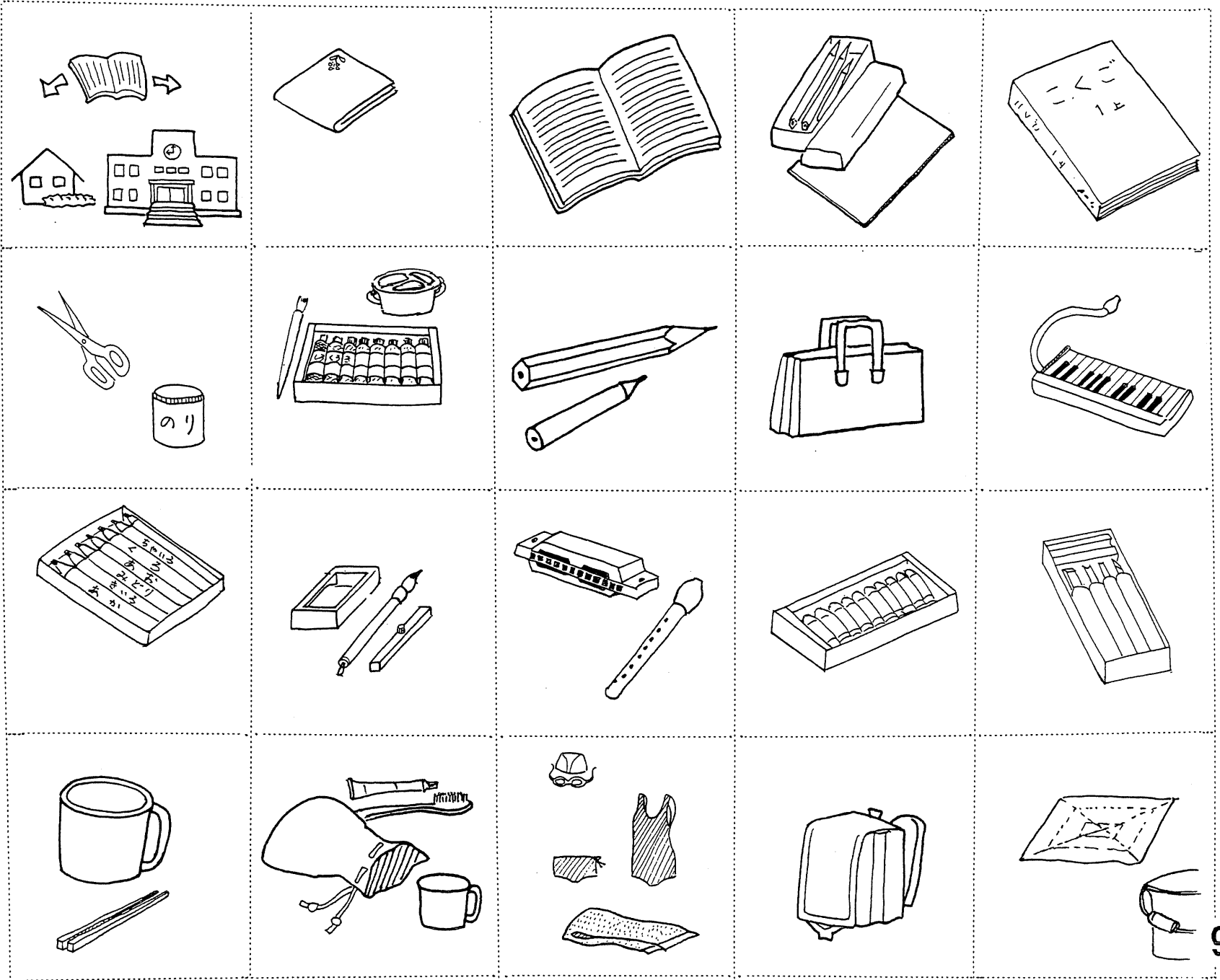

きょうかしよ

カ-ン 課本  
リ-ブ 本  
livro  
サカ シアキ 教科書  
sách giáo khoa

ふでばこ

ヒ-ホ 筆盒  
Iスト-ツ 文具  
estojo  
ホフ デン フ 筆筒  
hộp đựng bút chì

のーと  
(ノート)

ハ-ス 本  
本 子  
カ-ル 本  
caderno  
タフ ヴ 筆筒  
tập vở

はんかち  
(ハンカチ)

ショウ ハ 手帕  
レツ [ティッシュ]  
leño ショウ テ 手紙  
カシ タ 手紙  
khăn tay 紙  
papel  
シヤウ ラウ ミ 洗臉巾  
giây lau mặt

しゅくだい

サ-イ 仁  
作 業  
トラヴァ-リョ 作業  
trabalho  
ハイ タフ 筆筒  
bài tập

けんばん

はーもにか  
(ハーモニカ)

カ シ 口琴  
ハ-モニカ  
harmonica  
ケン アモニカ  
ken amônika

かばん

テ-バ 提包  
ハ-ダ パスタ  
pasta  
バ 包  
bào

えんぴつ

チエン ピ- 鉛筆  
テ-ピス 鉛筆  
lápiz  
フ 筆  
bút chì

えのぐ

ヤリホ ホ-エ-ズ 顔料 和筆  
Iスト-ツ チ ピンタ 絵具  
estojo de pintura  
マウ ス 水彩  
màu nước

はさみ

ツノ ス 剪子  
テッソ-ラ 剪子  
tesoura 剪子  
カ イ ケ 糰子  
cái káo 糰子  
cola 糰子  
keo dán 糰子

ちょうこくとう

チョウ コ 彫刻刀  
Iスパ-ダ チ タル 彫刻刀  
espada de talhar  
タカ フン キン 彫刻刀  
tạc tượng kiến

くれよん  
(クレヨン)

ラ ビ 蜡笔  
ツ-ス チ セラ 蜡笔  
giz de cera  
フン ゲ マ 蜡笔  
phấn vẽ màu

はーもにか  
(ハーモニカ)

カ シ 口琴  
カ-タ 口琴  
gaita  
ケン アモニカ ken amônika  
テ-ス 笛子  
フタ フ 笛子  
flauta doce

\*\*\*

しゅうじ  
どうぐ

シ-ス ヨウ ツ 习字用具  
マテリアル チ カリグラフィ- 习字用具  
material de caligrafia  
ス タフ ヴィエト 习字用具  
sự tập viết

いろえんぴつ

カ-イセ- チエン ピ- 彩色鉛筆  
ラ-ピス チ コル 彩色鉛筆  
lápiz de cor  
\*\*\*

ぞうきん

マ-フ 抹布  
トラップ 抹布  
trapo  
カシ ライ 抹布  
khăn lau bụi

らんどセル  
(ランドセル)

カ-シ シ-ヒ-シ-バ 背囊式皮书包  
モチラ mochila  
カシ テイ キョ 背囊式皮书包  
cặp đi học

みずぎ

カシ イ 游泳衣  
マ-イ 游泳衣  
maio  
フ タム 游泳衣  
đồ tắm

たおる  
(タオル)

マ-ツ 毛巾  
トルハ 毛巾  
カシ ライ 毛巾  
khăn lau

きゅうしよく  
ぶくろ

カ-ス 袋  
サコ 袋  
saco  
トイ ニョ 袋  
túi nhỏ

こっぷ  
(コップ)

カ-リ ヴ 玻璃杯  
コップ 玻璃杯  
copo  
カシ タク 玻璃杯  
cái tách

はし

カ-イ ス 筷子  
ハシ 筷子  
パズ-イ-ニョ pauzinhos  
テ-ア 筷子  
đũa

日本語指導教材「こんにちは」〔小学校版〕

---

平成6年3月15日 印刷  
平成6年3月30日 発行  
平成27年3月31日 改訂

編集 大阪府教育センター 教科第一室  
改訂 同 人権教育研究室

---

発行 大阪府教育センター  
大阪市住吉区苅田4丁目13番23号  
電話 06 (6692) 1882  
FAX 06 (6692) 1898